

**FP23 Series  
Programmable Controller  
Instruction Manual  
(Detailed version)**

2-input

Thank you for purchasing the Shimaden FP23 Series Programmable Controller. Check that the delivered product is the correct item you ordered. Do not begin operating this product until you have read and thoroughly understood the contents of this Instruction Manual (Detailed version).

**SHIMADEN CO., LTD.**

MFP023-E02-C  
July. 2017



---

## Request

Make sure that this Instruction Manual (Detailed version) is given to the final user of the device.

Keep this manual at the work site during operation of the FP23 Series.

## Preface

This Instruction Manual describes the basic functions and how to use "2-input: 1-output/2-output" FP23 Series Controllers.

For details on "2-input: 1-output/2-output" and "servo output," refer to separate manuals.

This Instruction Manual is meant for those will be involved in the wiring, installation, operation and routine maintenance of the FP23 Series. This manual describes the handling, installation and wiring procedures for operation.

While using this device, you should always follow the instructions written in this manual.

For safety precautions and potential damage to equipment and/or facilities, additional instructions are indicated by the following headings.

## Safety Precautions



### Warning

The FP23 Series digital controllers are control instruments designed for industrial use to control temperature, humidity and other physical values.

It must not be used in any way that may adversely affect the safety, health or working conditions of those who come into contact with the effects of its use. When used, adequate and effective safety countermeasures must be provided at all times by the user. No warranty, express or implied, is valid when this device is used without the proper safety countermeasures.



### Warning

- ◆ Before you start to use this device, install it in a control panel or the like and avoid touching the terminals.
  - ◆ Do not open this device's case, and touch the boards or inside of the case with your hands or a conductor. The user should never repair or modify this device. Doing so might cause an accident that may result in death or serious bodily injury from electric shock.
- 
-



## Caution

To avoid damage to connected peripheral devices, facilities or the product itself due to malfunction of this device, safety countermeasures such as proper installation of the fuse or installation of overheating protection must be taken before use. No warranty, express or implied, is valid in the case of use resulting in an accident without having taken the proper safety countermeasures.

- ◆ The warning mark on the plate affixed on the casing of this device warns you not to touch charged parts while this device is powered ON. Doing so might cause an electric shock.
- ◆ A means for turning the power OFF such as switch or a breaker must be installed on the external power circuit connected to the power terminal on this device. Fasten the switch or breaker at a position where it can be easily operated by the operator, and indicate that it is a means for powering this device OFF.
- ◆ This device does not have a built-in fuse. Install a fuse that conforms to the following rating in the power circuit connected to the power terminal.

**Fuse rating/characteristics: 250 VAC 1.0A/medium lagged or lagged type**

- ◆ When wiring this device, tighten the terminal connections firmly.
  - ◆ Use the device with the power voltage and frequency within their rated ranges.
  - ◆ Do not apply a voltage or current outside of the input rating to the input terminal. Doing so might shorten the service life of this device or cause it to malfunction.
  - ◆ The voltage and current of the load connected to the output terminal should be within the rated range. Exceeding this range may cause the temperature to rise which might shorten the service life of this device or cause it to malfunction.
  - ◆ This device is provided with ventilation holes for heat to escape. Prevent metal objects or other foreign matter from entering these ventilation holes as this may cause this device to malfunction. Do not block these ventilation holes or allow dirt and dust to stick to these holes. Temperature buildup or insulation failure might shorten the service life of this device or cause it to malfunction.
  - ◆ Repeated tolerance tests on voltage, noise, surge, etc. may cause this device to deteriorate.
  - ◆ Never remodel this device or use it a prohibited manner.
  - ◆ To ensure safe and proper use of this device, and to maintain its reliability, observe the precautions described in this manual.
  - ◆ Do not operate the keys on the front panel of this device with a hard or sharp-tipped object. Be sure to operate the keys with your fingertips.
  - ◆ When cleaning this device, do not use paint thinner or other solvents. Wipe gently with a soft, dry cloth.
  - ◆ It takes 30 minutes to display the correct temperature after applying power to the digital controller. (Therefore, turn the power on more than 30 minutes prior to the operation.)
-

## Check before use

This device has been fully checked for quality assurance before shipment from the factory. However, you are requested to make sure that there are no errors, damages or shortages in the delivered items by confirming the model code, external appearance of the device and the number of accessories.

### Confirmation of model codes

Referring to the table below check the model codes affixed to the case of the product to check if the respective codes indicate what was specified when you ordered the product.

### Checking accessories

Make sure that your product package has all of the following items

#### Standard accessories

- (1) Instruction Manual (A3 size paper ×4)
- (2) Mounting fixture (w/ 2 screws)
- (3) Terminal cover
- (4) Unit decal

#### Optional accessories

- (1) Current transformer (CT) for heater break alarm (when the heater break alarm option is selected)
- (2) Terminal resistor (when the RS-485 communication option is selected)

### Options (sold separately)

The following table shows the options available for this product.

| Model Name                     | Model No. | Specification                                      |
|--------------------------------|-----------|--|
| Infrared Communication Adapter | S5004     | USB Cable (2m)                                     |
| Shunt resistor                 | QCS002    | 250Ω±0.1%  |
| Relay Unit                     | AP2MC     | Converts open collector output to 2-point contact. |

Setup tool "Parameter Assistant" /USB driver can be downloadable FREE from the Shimaden website shown as below.

<http://www.shimaden.co.jp/english/support/index.html>

## ■ 2-input specification

| Item  | Code  | Specification  |  |
|---|-------|--|--|
| 1. Series                                   | FP23- | Multi-function programmable controller, DIN 96 x 96 mm |  |
| 2. Basic functions                          | *1    | DL   | Universal-input, independent 2-loop control, 3 event outputs                   |
|   |       | DS   | Universal-input, 2-input operation/1-output control, 3 event outputs *2        |
|   |       | DD   | Universal-input, 2-input operation/2-output control, 3 event outputs           |
| 3. Control Output 1                         | *2    | Y  | Contact 1c, Contact rating: 240 V AC, 2.5 A/resistive load, 1A/ inductive load |
|   |       | I  | Current 4 to 20 mA DC, Load resistance: 600Ω max.                              |
|   |       | P  | SSR drive voltage 12 V±1.5 V DC, Load current: 30 mA max.                      |
|   |       | V  | Voltage 0 to 10 V DC, Load current: 2 mA max.                                  |
| 4. Control Output 2                         |       | Y-   | Contact 1c, Contact rating: 240 V AC 2.5 A/resistive load, 1A/ inductive load  |
|   |       | I-   | Current 4 to 20 mA DC, Load resistance: 600Ω max.                              |
|   |       | P-   | SSR drive voltage 12 V±1.5 V DC, Load current: 30 mA max.                      |
|   |       | V-   | Voltage 0 to 10 V DC, Load current: 2 mA max.                                  |
| 5. Heater Break alarm<br>(for single phase) | *3    | 00   | None   |
|   |       | 31   | Heater Break alarm (heater Current 30 A, CT provided)                          |
|   |       | 32   | Heater Break alarm (heater current 50 A, CT provided)                          |
|   |       | Selectable only when Control Output 1 or 2 is Y or P   |  |
| 6. Analog Output 1                          |       | 0  | None   |
|   |       | 3  | 0 to 10 mV DC, Output resistance: 10Ω  |
|   |       | 4  | 4 to 20 mA DC, Load resistance: 300Ω max.                                      |
|   |       | 6  | 0 to 10 V DC, Load current: 2 mA max.  |
| 7. Analog Output 2/sensor power supply      |       | 0  | None   |
|   |       | 3  | 0 to 10 mV DC, Output resistance: 10Ω  |
|   |       | 4  | 4 to 20 mA DC, Load resistance: 300Ω max.                                      |
|   |       | 6  | 0 to 10 V DC, Load current: 2 mA max.  |
|   |       | 8  | Sensor power supply 24 V DC 25mA   |
| 8. External I/O control signals<br>(DI/DO)  | *4    | Standard   | 0 4 DI, 5 DO   |
|   |       | 1 10 DI, 9 DO  |  |
| 9. Communication interface                  |       | 0  | None   |
|   |       | 3  | RS-485 (not insulated)   |
|   |       | 5  | RS-485   |
|   |       | 7  | RS-232C  |
|   |       | SHIMADEN protocol/<br>MODBUS communication protocol    |  |
| 10. Remarks                                 |       | 0  | Standard firmware  |
|   |       | 1-9<br>A-Z   | Customized firmware  |

\*1 Independent 2-loop control, 2-input operation/1-output control and 2-input operation/2-output control are all supported in the 2-output specification.

The controller is shipped with the function selected at BASIC FUNCTION set.

\*2 In a 2-input operation/1-output control specification, output for control is output to Control Output1. Select the same specification as Control Output 2 for Control Output1 .

\*3 In a 2-output specification, the heater break alarm is used either of Control Output 1 or 2.

\*4 When switching the start pattern No. by D1, 10 points of D1 (CODE1) are required.

# Contents

|          |   |           |
|----------|---|-----------|
| <b>1</b> | <b>INSTALLATION &amp; WIRING</b> .....                        | <b>1</b>  |
| 1-1      | Installation Site .....                                       | 1         |
| 1-2      | External Dimensions and Panel Cutout .....                    | 1         |
| 1-3      | Mounting .....  | 2         |
| 1-4      | Current Transformer (CT) for Heater Break Alarm.....          | 3         |
| 1-5      | Rear Terminal Arrangement Diagrams .....                      | 4         |
| 1-6      | Wiring .....  | 6         |
| <b>2</b> | <b>NAMES &amp; FUNCTIONS OF PARTS ON FRONT PANEL</b> .....    | <b>7</b>  |
| <b>3</b> | <b>BASIC OPERATIONS</b> .....                                 | <b>13</b> |
| 3-1      | Power ON .....  | 13        |
| 3-2      | Switching LCD Screen Display and Moving the Cursor .....      | 14        |
| (1)      | Switching the screen display.....                             | 14        |
| (2)      | CH1, CH2: Switching channels.....                             | 14        |
| 3-3      | Changing and Registering Data.....                            | 15        |
| (1)      | Entering numerical values.....                                | 15        |
| (2)      | Selecting setup items.....                                    | 16        |
| <b>4</b> | <b>CONTROL MODES &amp; FUNCTION BLOCKS</b> .....              | <b>17</b> |
| 4-1      | Control Modes .....   | 17        |
| 4-2      | Reset State .....   | 17        |
| 4-3      | Program Functions .....                                       | 18        |
| 4-4      | CONTROL FUNCTION BLOCK DIAGRAMS .....                         | 20        |
| (1)      | 1-input, 1-output/2-output.....                               | 20        |
| (2)      | 2-input, 1-output/2-output.....                               | 21        |
| (2)      | 2-input, 1-output/2-output.....                               | 21        |
| (3)      | 2-input, 2-output, Independent 2-channel .....                | 22        |
| <b>5</b> | <b>SETUP</b> .....  | <b>23</b> |
| 5-1      | Parameter Setup Procedure .....                               | 23        |
| <b>6</b> | <b>OUTPUT SPECIFICATION &amp; KEY LOCK</b> .....              | <b>25</b> |
| 6-1      | Selection of operation mode under 2-input specification ..... | 25        |
| (1)      | Operation mode under 2-input, 2-output specification .....    | 25        |
| (2)      | Setting of Operation Mode under 2-Input Specification .....   | 26        |

---

|          |   |           |
|----------|---|-----------|
| 6-2      | Releasing the Key Lock .....                            | 27        |
| (1)      | Key lock screen display .....                           | 27        |
| (2)      | Releasing the key lock .....                            | 27        |
| <b>7</b> | <b>I/O SETTINGS, INFRARED COMMUNICATION .....</b>       | <b>29</b> |
| 7-1      | Output Specifications (2-output specification).....     | 29        |
| 7-2      | Infrared Communication .....                            | 30        |
| 7-3      | Measuring Range .....                                   | 30        |
| (1)      | Range setting .....                                     | 30        |
| (2)      | Range scaling.....                                      | 31        |
| 7-4      | Unit.....   | 34        |
| 7-5      | Decimal Point Position.....                             | 35        |
| (1)      | Decimal point position .....                            | 35        |
| (2)      | Switching the lowest digit past the decimal point ..... | 35        |
| 7-6      | Cold Junction Compensation.....                         | 36        |
| (1)      | Thermocouple cold junction compensation .....           | 36        |
| <b>8</b> | <b>I/O AUXILIARY SETTINGS.....</b>                      | <b>37</b> |
| 8-1      | Setup of 2-Input Operation .....                        | 37        |
| (1)      | Selection of PV Mode.....                               | 37        |
| (2)      | Process when scaleover occurs.....                      | 37        |
| (3)      | Bias, filter and slope .....                            | 38        |
| 8-2      | PV Compensation Value.....                              | 38        |
| (1)      | PV bias .....   | 38        |
| (2)      | PV filter.....  | 38        |
| (3)      | PV slope.....   | 38        |
| 8-3      | Square Root Extraction Operation.....                   | 39        |
| (1)      | Enabling the square root extraction operation.....      | 39        |
| (2)      | Low cut.....  | 39        |
| 8-4      | Control Output .....                                    | 40        |
| (1)      | Action characteristics .....                            | 40        |
| (2)      | Output at reset.....                                    | 40        |
| (3)      | Output at error .....                                   | 40        |
| (4)      | Proportional cycle time .....                           | 41        |
| (5)      | Setting output 2 .....                                  | 41        |
| 8-5      | Setting the Ten-Segment Linearizer Approximation .....  | 41        |
| (1)      | Enabling ten-segment linearizer approximation .....     | 41        |
| (2)      | Setting input points.....                               | 42        |
| 8-6      | Limiters .....  | 43        |
| (1)      | Output rate-of-change limiter.....                      | 43        |
| (2)      | SV limiter .....  | 43        |



|           |   |           |
|-----------|---|-----------|
| 8-7       | Compensating Control Output/Analog Output ..... | 44        |
| <b>9</b>  | <b>PROGRAM SETTINGS.....</b>                    | <b>45</b> |
| 9-1       | Program Initial Settings.....                   | 45        |
| (1)       | Time unit .....                                 | 45        |
| (2)       | Program start delay time.....                   | 45        |
| (3)       | Input error mode .....                          | 45        |
| (4)       | Power failure compensation.....                 | 46        |
| (5)       | Advance mode.....                               | 46        |
| (6)       | Advance time .....                              | 46        |
| (7)       | CH1 pattern number .....                        | 47        |
| 9-2       | Step-related Settings .....                     | 47        |
| (1)       | Step SV value .....                             | 47        |
| (2)       | Step Time.....                                  | 48        |
| (3)       | Step PID No.....                                | 48        |
| 9-3       | Pattern-related Settings .....                  | 48        |
| (1)       | Number of steps.....                            | 48        |
| (2)       | Start step .....                                | 49        |
| (3)       | Start SV .....                                  | 49        |
| (4)       | Pattern execution count .....                   | 50        |
| (5)       | Start step No. of step loop .....               | 50        |
| (6)       | End step No. of step loop.....                  | 51        |
| (7)       | Execution count of step loop.....               | 51        |
| (8)       | Guarantee soak zone.....                        | 52        |
| (9)       | Guarantee soak time.....                        | 53        |
| (10)      | PV start .....                                  | 53        |
| 9-4       | Pattern Link-related Settings .....             | 55        |
| (1)       | Setting the pattern link execution count.....   | 55        |
| (2)       | Pattern link.....                               | 55        |
| 9-5       | Settings Before Program Operation.....          | 56        |
| (1)       | Auto-tuning point.....                          | 56        |
| (2)       | Program EVENT/DO action points.....             | 57        |
| (3)       | Time signal (TS).....                           | 58        |
| (4)       | Start pattern No.....                           | 60        |
| <b>10</b> | <b>FIX SETTINGS.....</b>                        | <b>61</b> |
| 10-1      | Switching the FIX Mode.....                     | 61        |
| 10-2      | FIX SV Value .....                              | 61        |
| 10-3      | FIX PID No. ....                                | 62        |
| 10-4      | FIX MOVE .....                                  | 62        |
| 10-5      | FIX EVENT/DO Action Points.....                 | 63        |

---

|   |           |
|---|-----------|
| <b>11 PID SETTING</b> .....                           | <b>65</b> |
| 11-1 Proportional Band (P).....                       | 65        |
| 11-2 Integral Time (I).....                           | 65        |
| 11-3 Derivative Time (D).....                         | 66        |
| 11-4 Manual Reset (MR).....                           | 66        |
| 11-5 Action Hysteresis (DF).....                      | 67        |
| 11-6 Dead Band (DB).....                              | 67        |
| 11-7 Set Value Function (SF).....                     | 69        |
| 11-8 Output Limit Value (OUT1L to OUT2H).....         | 70        |
| 11-9 Zone PID.....                                    | 71        |
| (1) Selecting Zone PID.....                           | 71        |
| (2) Zone hysteresis.....                              | 72        |
| (3) PID zone value.....                               | 72        |
| <b>12 EVENT &amp; DO SETTING</b> .....                | <b>73</b> |
| 12-1 Monitor Screens.....                             | 73        |
| (1) DO monitor.....                                   | 73        |
| (2) Logic monitor.....                                | 73        |
| 12-2 Channel Setting.....                             | 73        |
| 12-3 EVENT/DO Action.....                             | 73        |
| (1) Output characteristics.....                       | 75        |
| (2) Hysteresis.....                                   | 75        |
| (3) Delay time.....                                   | 76        |
| (4) Inhibit Action.....                               | 76        |
| 12-4 Event Logic Operations.....                      | 77        |
| (1) Logic operation mode (Log MD).....                | 77        |
| (2) Assigning logic operation input (SRC1, SRC2)..... | 77        |
| (3) Logic operation input logic (Gate1, Gate2).....   | 78        |
| 12-5 Timers/Counters.....                             | 78        |
| (1) Timer time.....                                   | 78        |
| (2) Counter.....                                      | 78        |
| (3) Assigning input (SRC).....                        | 79        |
| (4) Mode (Log MD).....                                | 79        |
| <b>13 OPTION SETTINGS (DI, AO, HB, COM)</b> .....     | <b>81</b> |
| 13-1 DI.....  | 81        |
| (1) DI monitor screen.....                            | 81        |
| (2) Assignment of a Channel to DI.....                | 81        |
| (3) List of DI Types.....                             | 81        |

|           |  |           |
|-----------|--|-----------|
| 13-2      | Analog Output.....   | 84        |
| (1)       | Analog Output type .....                                   | 84        |
| (2)       | Scaling Analog Output .....                                | 84        |
| 13-3      | Setting the Heater Break/Heater Loop Alarms.....           | 85        |
| (1)       | Connecting the Current Transformer (CT) .....              | 85        |
| (2)       | Heater current monitor .....                               | 85        |
| (3)       | Heater Break Alarm current (HBA) .....                     | 85        |
| (4)       | Heater Loop Alarm current (HLA) .....                      | 86        |
| (5)       | Heater Break/Heater Loop Alarm mode (HBM) .....            | 86        |
| (6)       | Heater Break detection Selection (HB) .....                | 86        |
| 13-4      | Communication.....   | 87        |
| (1)       | Setting communication.....                                 | 87        |
| (2)       | Communication Mode (COM) .....                             | 88        |
| <b>14</b> | <b>KEY LOCK SETTING.....</b>                               | <b>89</b> |
| 14-1      | Setting Key Lock.....                                      | 89        |
| (1)       | Displaying the key lock screen.....                        | 89        |
| (2)       | Key lock .....   | 89        |
| <b>15</b> | <b>MONITORING, EXECUTING &amp; STOPPING OPERATION.....</b> | <b>91</b> |
| 15-1      | Flow of Basic Screen under 2-loop Specification.....       | 91        |
| 15-2      | Operations in Basic Screen .....                           | 92        |
| (1)       | Setting the start pattern.....                             | 92        |
| (2)       | Setting the start step .....                               | 92        |
| (3)       | Setting the FIX mode .....                                 | 93        |
| (4)       | Setting the FIX SV value (only in FIX mode) .....          | 93        |
| 15-3      | Displaying the Step No. and SV .....                       | 94        |
| 15-4      | How to Start / Stop Control .....                          | 94        |
| <b>16</b> | <b>OPERATIONS DURING CONTROL.....</b>                      | <b>95</b> |
| 16-1      | Monitoring Control .....                                   | 95        |
| (1)       | Basic screen .....   | 95        |
| (2)       | Output value display .....                                 | 95        |
| (3)       | PV monitor .....   | 95        |
| (4)       | Status monitor.....  | 96        |
| (5)       | Monitoring program status .....                            | 96        |
| (6)       | Monitoring the remaining step time.....                    | 96        |
| (7)       | Monitoring the program.....                                | 96        |
| (8)       | Monitoring the pattern link.....                           | 97        |
| (9)       | Monitoring information during control execution .....      | 97        |

---

|           |   |            |
|-----------|---|------------|
| 16-2      | Executing and Stopping Auto Tuning .....                      | 98         |
| 16-3      | Switching Auto/Manual of Control Output .....                 | 100        |
| (1)       | Manual output operations .....                                | 100        |
| (2)       | Simple key-based manual output operations .....               | 101        |
| 16-4      | Temporarily Holding (HLD) and Resuming Program Execution..... | 101        |
| 16-5      | Executing Advance (ADV) .....                                 | 102        |
| <b>17</b> | <b>ERROR DISPLAYS.....</b>                                    | <b>105</b> |
| 17-1      | Operation Check Abnormalities at Power ON.....                | 105        |
| 17-2      | PV Input Abnormalities .....                                  | 106        |
| 17-3      | Heater Current Abnormalities (option) .....                   | 106        |
| <b>18</b> | <b>LIST OF PARAMETERS .....</b>                               | <b>107</b> |
| 18-1      | Execution Screen Group (group 1) .....                        | 107        |
| 18-2      | Program Screen Group (group 2) .....                          | 108        |
| 18-3      | Step Screen Group (group 2S) .....                            | 109        |
| 18-4      | PID Screen Group (group 3).....                               | 110        |
| 18-5      | EVENT/DO Screen Group (group 4) .....                         | 111        |
| 18-6      | DI/Option Screen Group (group 5).....                         | 113        |
| 18-7      | Control Output Screen Group (group 6) .....                   | 116        |
| 18-8      | Unit/Range Screen Group (group 7).....                        | 117        |
| 18-9      | Lock, etc. Screen Group (group 8) .....                       | 119        |
| <b>19</b> | <b>PARAMETER SETUP RECORD SHEETS .....</b>                    | <b>121</b> |
| 19-1      | Product Model Code .....                                      | 121        |
| 19-2      | CTRL EXEC Parameters .....                                    | 121        |
| 19-3      | PROG STEP Parameters .....                                    | 122        |
| 19-4      | PID Parameters .....  | 125        |
| 19-5      | EVENT/DO Parameters .....                                     | 126        |
| 19-6      | DI/Options Parameters .....                                   | 127        |
| 19-7      | Control Output Parameters.....                                | 127        |
| 19-8      | Unit/Measuring Range Parameters .....                         | 127        |
| 19-9      | Lock, etc. Parameters.....                                    | 128        |
| <b>20</b> | <b>SPECIFICATIONS .....</b>                                   | <b>129</b> |
| 20-1      | Display .....   | 129        |
| 20-2      | Setting .....   | 129        |
| 20-3      | Input .....   | 130        |
| 20-4      | Control .....   | 131        |
| 20-5      | Program Function .....  | 132        |

---

|       |                                    |     |
|-------|------------------------------------|-----|
| 20-6  | Event Output.....                  | 133 |
| 20-7  | External Control Output (DO) ..... | 134 |
| 20-8  | External Control Input (DI).....   | 134 |
| 20-9  | Logic Operation Functions.....     | 135 |
| 20-10 | 2-input Specification .....        | 135 |
| 20-11 | Heater Break Alarm (option).....   | 136 |
| 20-12 | Analog Output (option).....        | 136 |
| 20-13 | Sensor Power Supply (option).....  | 137 |
| 20-14 | Communication (option).....        | 137 |
| 20-15 | Infrared Communication .....       | 138 |
| 20-16 | General Specifications.....        | 138 |

# LCD Flow Chart

The following shows how to move between the LCD display screens of this device.

- Standard screen Screens that are always displayed
- Non-standard screen Screens that are displayed depending on options/setup values.

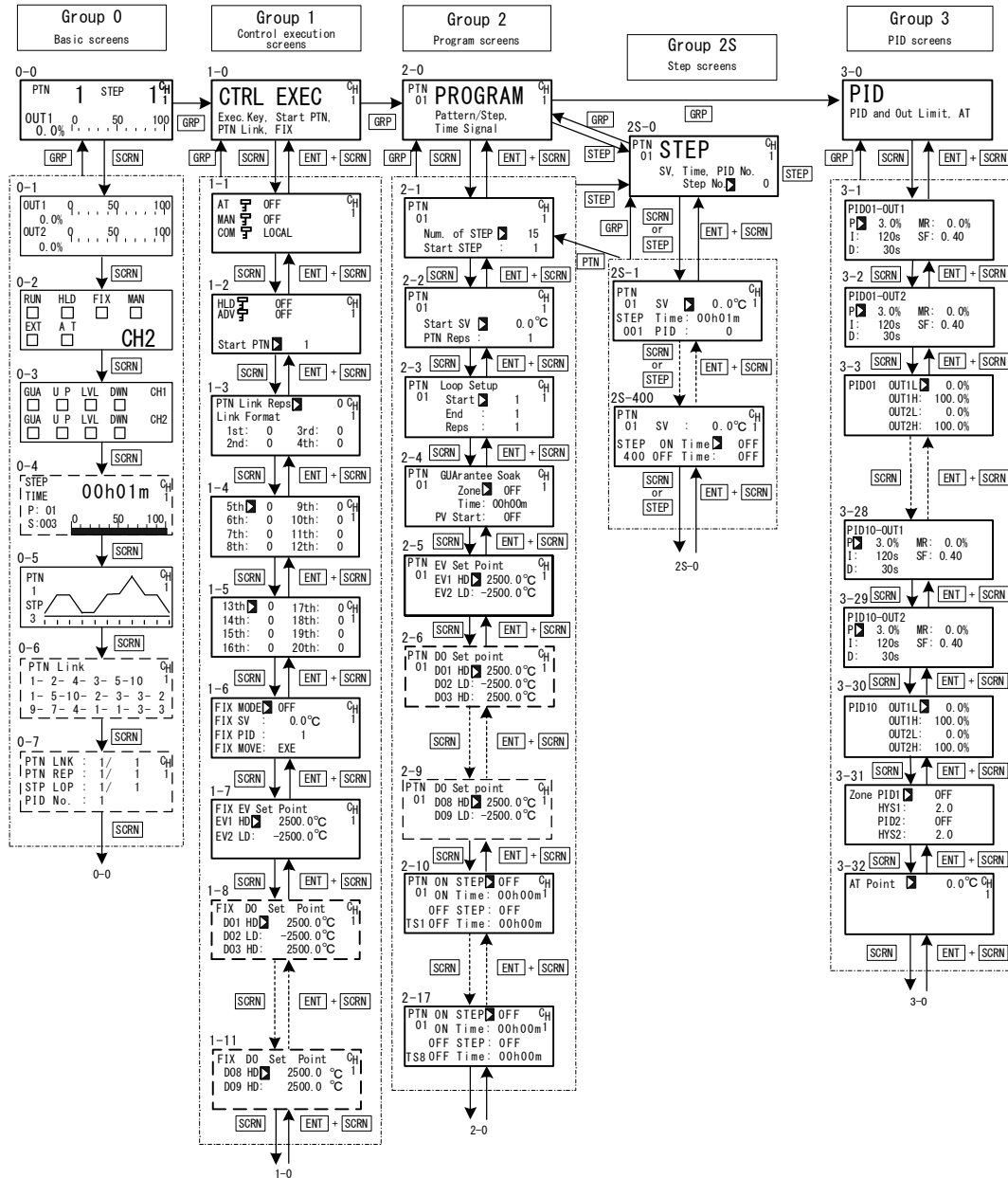

When the **[DISP]** key is pressed at a screen other than the 0-0 basic screen, the 0-0 basic screen is returned to.

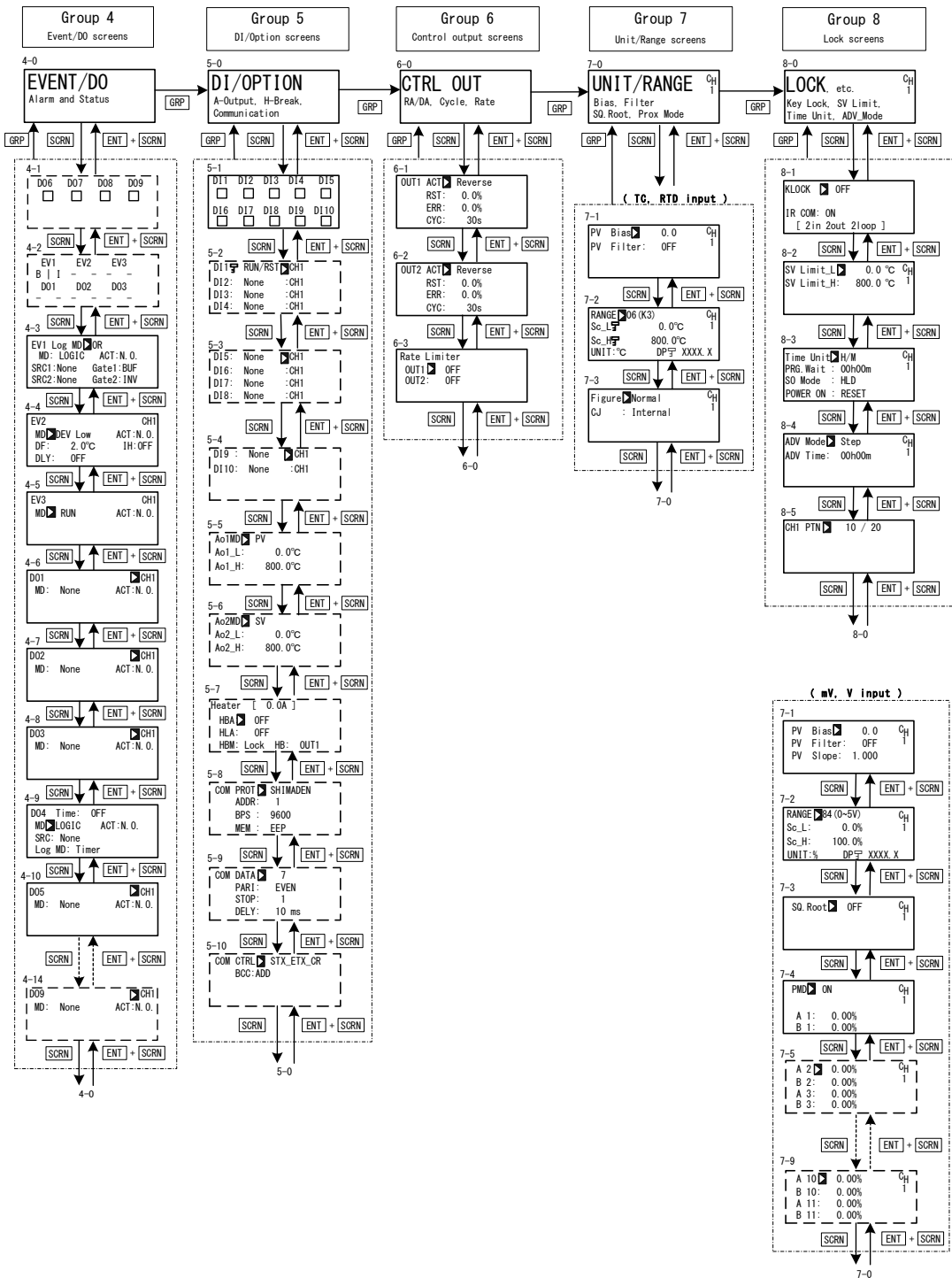

This page left intentionally blank.



# 1 INSTALLATION & WIRING

## 1-1 Installation Site



### Caution

Do not use this device in the following sites. Doing so might result in malfunction or damage to this device and in some cases cause fire and/or dangerous situations.

- ◆ Locations that are filled with or generate inflammable gas, corrosive gas, dirt and dust, smoke, etc.
- ◆ Locations that are subject to water droplets, direct sunlight or strong radiated heat from other equipment
- ◆ Locations where the ambient temperature falls below  $-10^{\circ}\text{C}$  or rises above  $50^{\circ}\text{C}$
- ◆ Locations where dew condensation forms and the humidity reaches 90% or more
- ◆ Near equipment that generates high-frequency noise
- ◆ Near heavy current circuits or locations likely to be subject to inductive interference
- ◆ Locations subject to strong vibration and impact
- ◆ Locations exceeding an elevation of 2000 m

## 1-2 External Dimensions and Panel Cutout

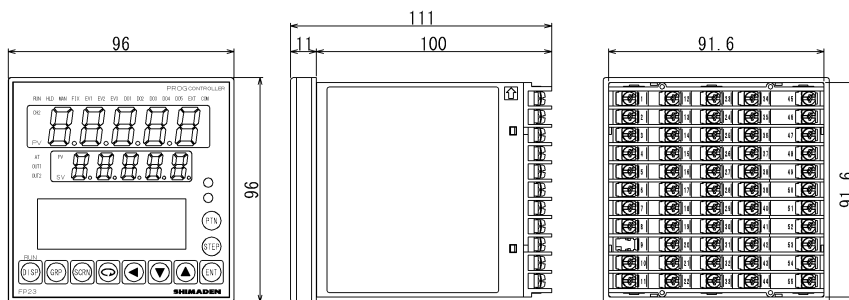

### External dimensions

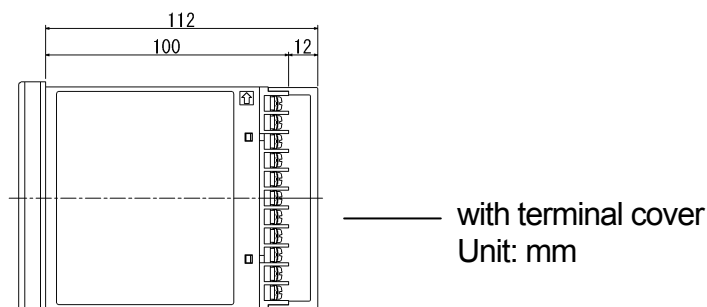

## Panel cutout dimensions and space for gang mounting

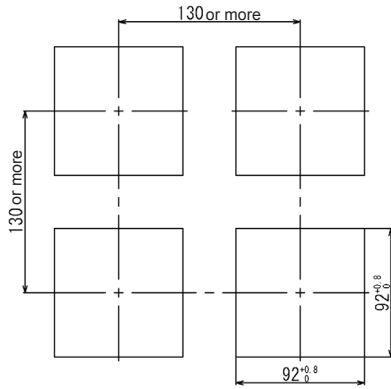

Unit: mm

### 1-3 Mounting



## Caution

To ensure safety and maintain the functions of this device, do not disassemble this device.  
If this device must be disassembled for replacement or repair, contact your dealer.

Follow the procedure below to mount this device on a panel.

1. Drill mounting holes referring to the panel cutout dimensions described in the previous section.  
The applicable thickness of the mounting panel is 1.0 to 8.0 mm.
2. Press this device into the panel from the front of the panel.
3. Insert the mounting fixtures at the top and bottom of this device, and tighten the screws from behind to fasten the device in place.
4. Over-tightening the screws may deform or damage the device housing. Take care not to tighten the screws too tight.
5. After completing wiring after installation, attach the terminal cover.

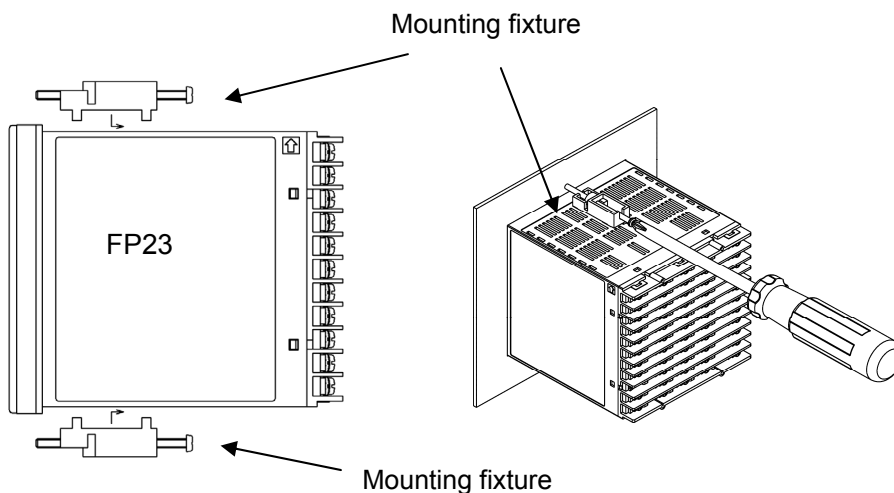

### 1-4 Current Transformer (CT) for Heater Break Alarm

The CT can be used when the heater Break alarm (option) is selected in the product specifications.

Either of the following CT is provided.

■ For 0 to 30A (CTL-6-S)

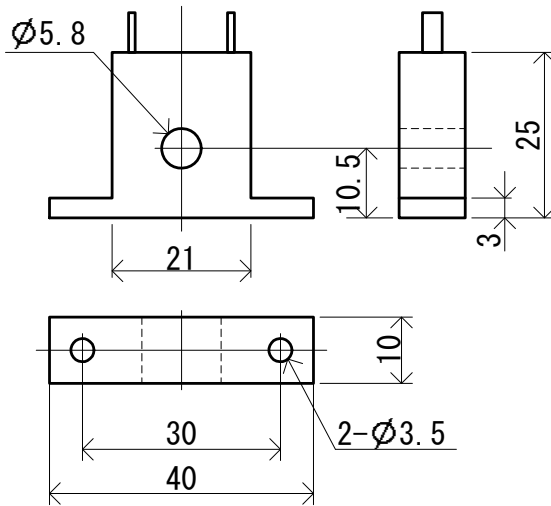

Unit: mm

■ For 0 to 50A (CTL-12-S36-8)

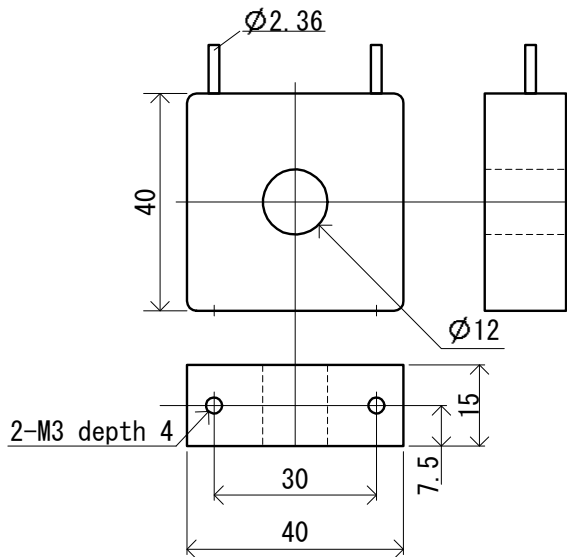

Unit: mm

### 1-5 Rear Terminal Arrangement Diagrams

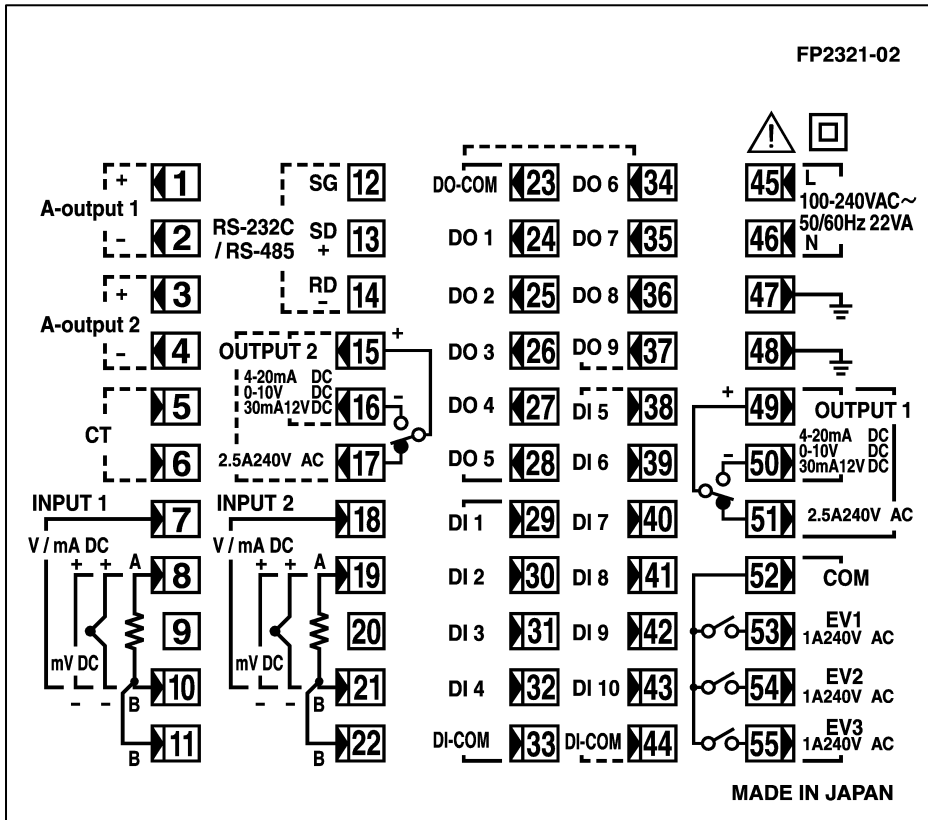

| Terminal No | Symbol | Description                                       |                       |
|-------------|--------|---|-----------------------|
| 1           | +      | Analog output 1 (optional)                        |                       |
| 2           | -      |   |                       |
| 3           | +      | Analog output 2 or Sensor Power Supply (optional) |                       |
| 4           | -      |   |                       |
| 5           | +      | Heater break alarm CT input (optional)            |                       |
| 6           | -      |   |                       |
| 8           | +      | mV, Thermocouple input                            | Input 1               |
| 10          | -      |   |                       |
| 8           | A      | RTD input   |                       |
| 10          | B      |   |                       |
| 11          | B      |   |                       |
| 7           | +      | V, mA input                                       |                       |
| 10          | -      |   |                       |
| 45          | L      | Power supply                                      |                       |
| 46          | N      |   |                       |
| 47          |        | Grounding ( internal shorting across terminals )  |                       |
| 48          |        |   |                       |
| 49          | COM+   | Control output 1                                  |                       |
| 50          | NO -   |   |                       |
| 51          | NC     |   |                       |
| 52          | COM    | Event output EV ( standard )                      |                       |
| 53          | EV1    |   |                       |
| 54          | EV2    |   |                       |
| 55          | EV3    |   |                       |
| 23          | COM    | External control output DO ( standard )           | Darlington output     |
| 24          | DO1    |   |                       |
| 25          | DO2    |   |                       |
| 26          | DO3    |   | Open collector output |
| 27          | DO4    |   |                       |
| 28          | DO5    |   |                       |

| Terminal No. | Symbol | Description   |  |
|--------------|--------|---|--|
| 29           | DI1    | External control output D1 ( standard )                       |  |
| 30           | DI2    |   |  |
| 31           | DI3    |   |  |
| 32           | DI4    |   |  |
| 33           | COM    |   |  |
| 34           | DO6    | External control output DO Open collector output ( optional ) |  |
| 35           | DO7    |   |  |
| 36           | DO8    |   |  |
| 37           | DO9    |   |  |
| 38           | DI5    | External input DI5 to DI10 ( optional )                       |  |
| 39           | DI6    |   |  |
| 40           | DI7    |   |  |
| 41           | DI8    |   |  |
| 42           | DI9    |   |  |
| 43           | DI10   |   |  |
| 44           | COM    |   |  |
| 12           | SG     | Communication function ( optional )                           |  |
| 13           | SD+    |   |  |
| 14           | RD -   |   |  |
| 15           | COM+   | Control output 2 ( optional )                                 |  |
| 16           | NO -   |   |  |
| 17           | NC     |   |  |

|    |   |                        |         |
|----|---|------------------------|---------|
| 19 | + | mV, Thermocouple input | Input 2 |
| 21 | - |                        |         |
| 19 | A | RTD input              |         |
| 21 | B |                        |         |
| 22 | B |                        |         |
| 18 | + | V, mA input            |         |
| 21 | - |                        |         |

A receiving resistor of 1/2W 250Ω 0.1% is attached across input terminals (7-10) for use for the 0 to 20mA, and 4 to 20mA inputs.

**Note**

Make sure that the input wiring is the shortest in case Input 1 and Input 2 share the same ground line. Otherwise, PV display accuracy might be affected.

## 1-6 Wiring

### Caution

- To prevent electric shock, always turn off and disconnect this device from the power supply before starting wiring.
- Do not touch wired terminals or charged parts with your hands while the power is supplied.

Pay attention to the following points when performing wiring:

- ◆ Check that the wiring is free from mistakes according to "1-5 Rear Terminal Arrangement Diagrams."
- ◆ Use crimped terminals that accommodate an M3 screw and that have a width of 6.2 mm or less.
- ◆ For thermocouple input, use a compensation wire compatible with the type of thermocouple.
- ◆ For RTD input, the resistance of a single lead wire must be 10 $\Omega$  or less and the three wires must have the same resistance.
- ◆ The input signal lead must not be passed along the same conduit or duct as that for high-voltage power lines.
- ◆ Shield wiring (single point grounding) is effective against static induction noise.
- ◆ Short interval twisted pair wiring is effective against electromagnetic induction noise.
- ◆ When wiring, use wire or cable (minimum 1 mm<sup>2</sup> cross-sectional area) of 600 V grade PVC insulated wire or equivalent wire having the same rating.
- ◆ For wiring the ground, ground the ground terminal with the earth resistance at less than 100 $\Omega$  and with wire 2 mm<sup>2</sup> or thicker.
- ◆ Two earth terminals are provided, each connected internally. One is for the ground connection, and the other is for connecting the shield of the signal lead. Do not use the earth terminals for crossover wiring of the power system ground lead.
- ◆ If this device is considered as being susceptible to noise caused by the power supply, attach a noise filter to prevent abnormal functioning. Install a noise filter onto a grounded panel, and make the wire connecting the noise filter output and the power supply terminal on this controller as short as possible.

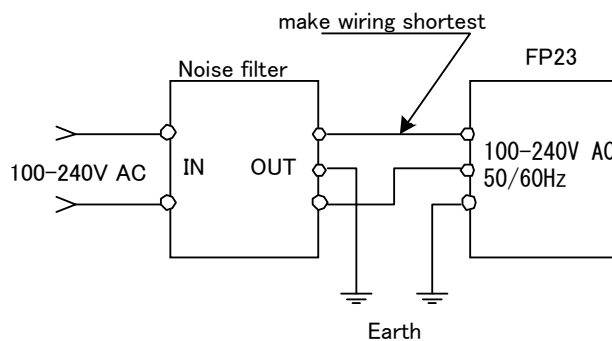

Recommended filter: RSEL-2003W from TDK

## 2 NAMES & FUNCTIONS OF PARTS ON FRONT PANEL

If the instrument is 2-loop specification, it has three kinds of display mode. The display mode can be switched to another by pressing **[DISP]** key on the front panel.

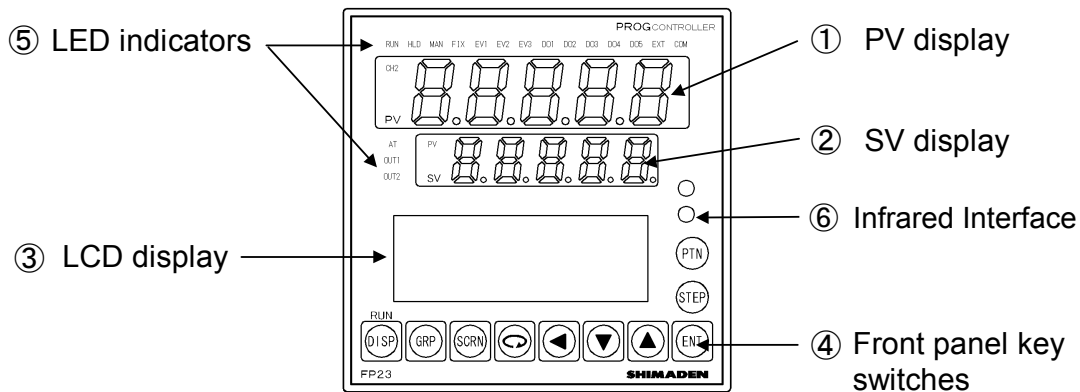

### ① PV display

#### For 2-loop;

Display mode 1: Displays the current measured value (PV) or an error message of CH1.

Display mode 2: Displays the current measured value (PV) or an error message of CH2.

Display mode 3: Displays the current measured value (PV) or an error message of CH1.

#### For other than 2-loop;

Displays the measured value (PV) or an error message.

### ② SV display

#### For 2-loop;

Display mode 1: Displays the target set value (SV) of CH1.

Display mode 2: Displays the target set value (SV) of CH2.

Display mode 3: Displays the current measured value (PV) of CH2.

#### For other than 2-loop;

Displays the target set value (SV).

#### Note

- ◆ When it is under Display mode 1, CH1 PV value is shown on the PV display, and CH1 SV value is shown on the SV display.
- ◆ Display mode 2 or 3 is only for 2-loop (Independent 2-channel) specification.
- ◆ When it is under Display mode 2 (when CH2 lamp lights), CH2 PV value is shown on the PV display, and CH2 SV value is shown on the SV display. When it is under Display mode 3 (when PV lamp lights), CH1 PV value is shown on the PV display, and CH2 PV value is shown on the SV display.
- ◆ For details, see “15-1 Flow of Basic Screen under 2-loop Specification”

### ③LCD display (21 characters x 4 lines, max.)

For 2-loop, the following "CH1" information is displayed under Display mode 1 or 3, and the following "CH2" information is displayed under Display mode 2.

#### **Pattern/step No. display**

Displays the pattern/step No. in the Program mode.

In the FIX mode, "F" is displayed at the PTN field and "- -" is displayed at the STEP field.

"- -" at the STEP field goes out during control execution (RUN) in the FIX mode.

#### **Output (OUT) display**

The control output value is displayed by a numerical value and a bar graph as a percentage (%).

#### **Channel (CH1 or CH2)**

Displays the current channel for the data as one of the parameter values (2-loop specification only).

#### **IN1/IN2 PV**

Displays the PV values of INPUT1/INPUT2 (2-input specification only).

#### **CH1/CH2 actions**

Displays the actions of the channel that is not displayed on LED indicators. (2-loop specification only).

#### **Program monitor display**

Displays the program status monitor.

#### **Remaining step time display**

Displays the remaining step time during program operation.

#### **Pattern graph display**

Displays the pattern (step) graph during program operation.

#### **Screen title display**











Displays the screen group title in the respective screen group top screen.

#### **Setup parameter display**



Parameters can be selected and displayed by front key operation.



#### ④ Front panel key switches

|   |                 |   |
|---|-----------------|---|
|  | (Display key)   | Displays the basic screen. Switches three Display mode.   |
|  | (Group key)     | Changes the screen group.<br>Or, returns to the screen group top screen.                                  |
|  | (Screen key)    | Switches the parameter display screen in a screen group.  |
|  | (Parameter key) | Selects the parameter to set up or change.<br>The parameter to be changed is indicated by the cursor (▶). |
|  | (Shift key)     | Moves the digit in set numerical values.  |
|  | (Down key)      | Decrements parameters and numerical values during setup.  |
|  | (Up key)        | Increments parameters and numerical values during setup.  |
|  | (Entry key)     | Registers data or parameter numerical values.   |
|  | (Step key)      | At a reset, increments the start step No. in the basic screen.<br>(ENT must be pressed to register.)      |
|  | (Pattern key)   | At a reset, increments the start pattern No. in the basic screen.<br>(ENT must be pressed to register.)   |

The following key combination operations are available in screens from 0-1 to 0-7.

 +  : Hold (HLD) operation

 +  : Advance (ADV) operation

### ⑤ LED indicators

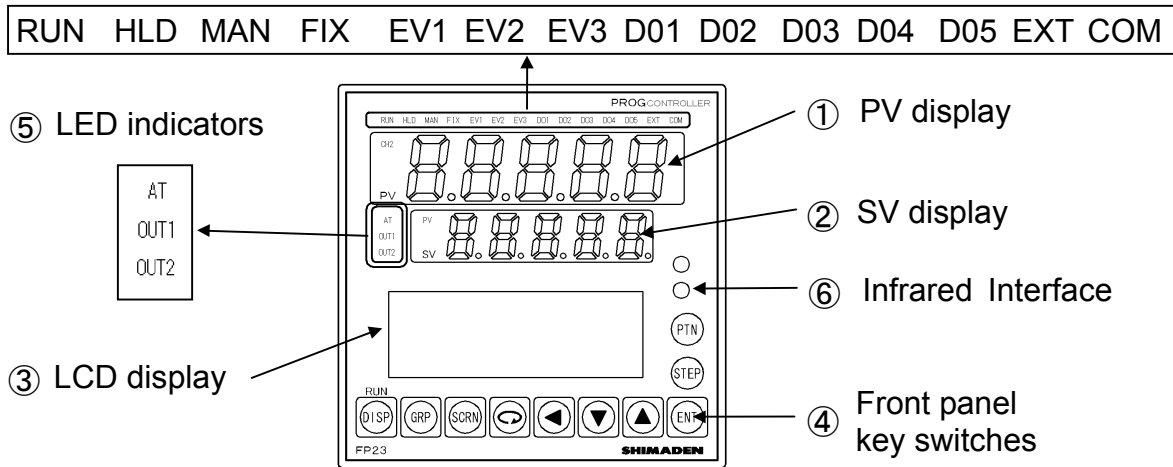

Note that for 2-loop specification, each RUN, HLD, MAN, FIX, EXT, AT lamp shows different channel information depending on the Display mode.

#### For 2-loop;

Display mode 1: Displays the action status of CH1.

Display mode 2: Displays the action status of CH2.

Display mode 3: Displays the action status of CH1.

#### For other than 2-loop;

Displays the action status.

### ■ Status lamps

|     |        |   |
|-----|--------|---|
| RUN | green  | Lights during control is being executed. Blinks during program start delay time (PRG.Wait).   |
| HLD | green  | Lights when the program is paused in Program mode. Blinks when the pause has caused by an input error in the Program mode or in the Fix mode. |
| MAN | green  | Blinks when control output is set to manual operation (MAN).  |
| FIX | green  | Lights in the FIX mode.   |
| EV1 | orange | Lights during EV1 action.   |
| EV2 | orange | Lights during EV2 action.   |
| EV3 | orange | Lights during EV3 action.   |
| DO1 | orange | Lights during DO1 action.   |
| DO2 | orange | Lights during DO2 action.   |
| DO3 | orange | Lights during DO3 action.   |
| DO4 | orange | Lights during DO4 action.   |
| DO5 | orange | Lights during DO5 action.   |
| EXT | green  | Lights when start pattern No. selection (PTN2bit, PTN3bit, PTN4bit, PTN5bit) are set to DI5 to DI8.   |
| COM | green  | Lights during communication (COM) mode.   |
| AT  | green  | Lights during auto tuning standby. Blinks during auto tuning execution.   |

- OUT1 green When control output is current or voltage output, the brightness of this lamp changes according to fluctuation of Control Output 1, and during contact or SSR drive voltage output, this lamp lights when Control Output 1 is ON and goes Out when Control Output 1 is OFF.
- OUT2 green When control output is current or voltage output, the brightness of this lamp changes according to fluctuation of Control Output 2, and during contact or SSR drive voltage output, this lamp lights when Control Output 2 is ON and goes Out when Control Output 2 is OFF.

■ **Monitor lamps**

- CH2 green Lights when CH2 PV/SV values are displayed on PV/SV display respectively.
- PV green Lights when CH2 PV value is displayed on SV display.

This page left intentionally blank.

# 3 BASIC OPERATIONS

## 3-1 Power ON

When the power is turned ON, the basic screen is displayed after the initial screens are displayed on the LCD for about three seconds.

When the FP23 is powered ON for the first time, check on screen to make sure that this device is the one you ordered.

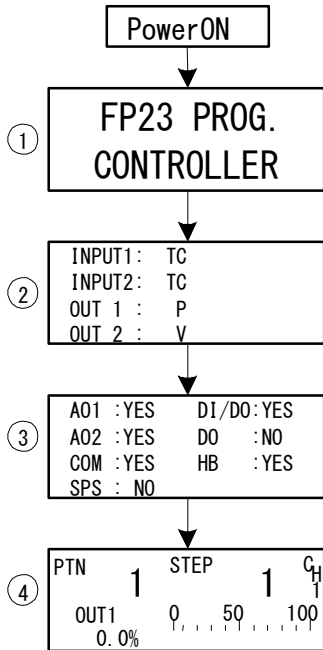

- ① **The series name is displayed.**
- ② **The I/O type is displayed.**  
The figure shows a thermocouple (TC) set for Input 1 and Input2, SSR drive voltage (P) set for Output 1, and voltage output (V) set for Output 2.
- ③ **The installation status of option functions is displayed.**  
The figure shows that Analog Output 1, Analog Output 2 and the communication function are installed (YES), DI (10 points) and DO (9 points) are installed (YES), and the heater break alarm are installed (YES), and SPS (sensor power supply) is not available (NO).
- ④ **Basic screen (Monitor Group top screen)**  
The figure shows that Output 1 of PTN1 CH1 is 0% in a 2-loop (2-channel) specification.

The details displayed on screen vary according to specifications, or according to preset function specifications.

*Note*

- ◆ The actually installed numbers for external DI or DO can be confirmed with the above ③ screen.

| LCD Display |    | Actual numbers |    |
|-------------|----|----------------|----|
| DI/DO       | DO | DI             | DO |
| NO          | NO | 4              | 5  |
| YES         | NO | 10             | 9  |

### 3-2 Switching LCD Screen Display and Moving the Cursor

#### (1) Switching the screen display

For details on moving between screens, see "LCD Flow Chart" in the preface.

The operation screens of this device are configured so that screens are displayed in order from the most frequently used screen in regular use.

The following shows an example of screens in the 1-input/1-output specification.

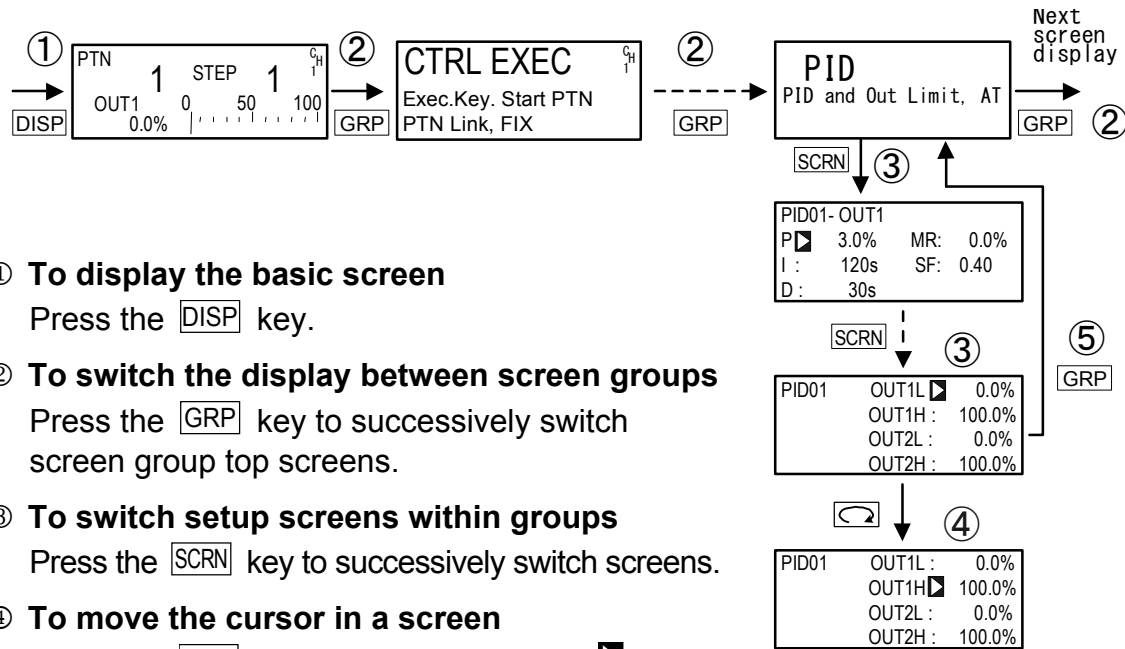

- ① **To display the basic screen**  
Press the [DISP] key.
- ② **To switch the display between screen groups**  
Press the [GRP] key to successively switch screen group top screens.
- ③ **To switch setup screens within groups**  
Press the [SCRN] key to successively switch screens.
- ④ **To move the cursor in a screen**  
Press the [↔] key to move the cursor (▣: blinking) when there are two or more parameters in the same screen.
- ⑤ **To display the top screen**  
Press the [GRP] key in a respective parameter setup screen other than the basic screen group to switch to the top screen of a screen group.

#### (2) CH1, CH2: Switching channels

This is about the operation sequence for 2-loop operation.

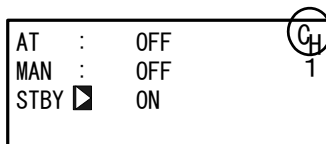

Displayed under reversed mode and blinking









Press [↔] key for moving the cursor (▣: blinking) to CH and select channel with [▲], [▼] keys. Press [ENT] for switching channels, and the contents for the selected channel will be displayed on the screen.

After having made the above-mentioned operations under the 2-loop specification, you will find the CH Number of the PV displayed on the basic screen (Group 0) when you return to the basic screen by pressing the [GRP] key or the like. And then the screen display will change to the one for the switched channel.

### 3-3 Changing and Registering Data

Basically, set up and change parameters while confirming the LCD screen display.

#### (1) Entering numerical values

1. When there are two or more parameters, press the  key to move the cursor () to the parameter to be changed.
2. Press the  or  ,  keys. The smallest digit of the numerical value blinks.
3. Press the  key again. Move the blinking section in the numerical value to the digit to be changed, and change the value using the  or  key.
4. Press the  key. The numerical value is fixed and registered, and stops blinking.

#### ■ Changing a numerical value setting (example)

The following shows the procedure for changing the value of PID parameter I to 100 s.

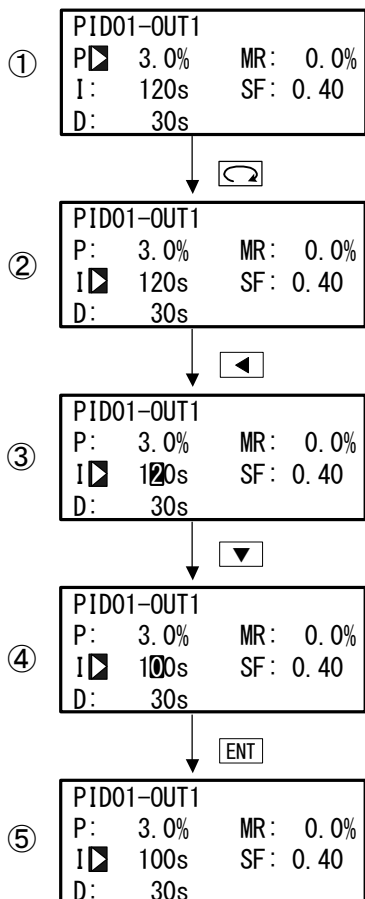



#### ① To move between screens

Press the  key three times in the initial screen to display the top screen of the PID screen (group 3).

Next, press the  key once.

#### ② To move the cursor from P to I

Press the  key once to move the blinking cursor () to I.

#### ③ To make the I numerical value blink and move to the 10's digit

Press the  key twice to move the blinking cursor to the 10's digit.

#### ④ To change the numerical value of the 10's digit to 0





Press the  key to change the display from "2" to "0".

#### ⑤ To fix and register the setting

Press the  key to fix the new setting.

## (2) Selecting setup items

The settings of parameters marked by a  key mark cannot be changed.

1. When there are two or more parameters, press the  key to move the cursor () to the parameter to be changed.
2. Change the parameter settings by the  or  key, check the setting, and press the  key to fix and register settings. The character stops blinking.

### ■ Selecting a parameter (example)

The following shows the procedure for changing control output to manual in the RUN mode.

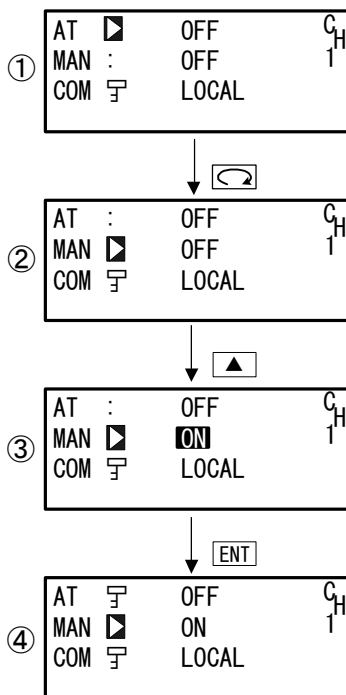



#### ① To move between screens

Press the  key once in the initial screen to display the top screen of the execution screen (group 1).

Next, press the  key once.

#### ② To move the cursor from AT to MAN

Press the  key once to move the blinking cursor () to MAN.

#### ③ To change the MAN setting from OFF to ON

Press the  key to change the display from OFF to ON.

#### ④ To fix and register the setting

Press the  key to fix the new setting.

In this case, Auto Tuning can no longer be executed, and the key mark is displayed.



## 4 CONTROL MODES & FUNCTION BLOCKS

### 4-1 Control Modes

The FP23 has two control modes.

They are the "Program mode" for performing program operation, and the "FIX mode" for performing fixed value control.

The following illustrates how to move between the two modes.

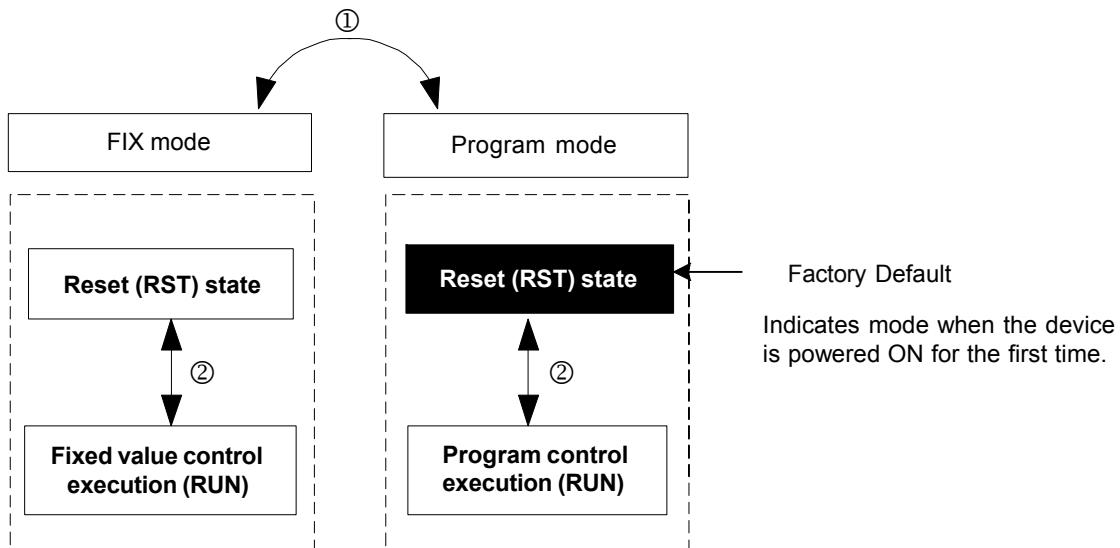

1. The control mode is switched by the FIX mode ON/OFF settings in the FIX MODE screen (No.1 to 6). The Mode switches to the FIX (fixed value) mode when ON is set, and to the Program mode when OFF is set.
2. Switch RST/RUN by the **ENT** + **DISP** keys.

### 4-2 Reset State

The FP23 does not execute control when it is in a Reset State in both the Program mode and the FIX mode.

Note, however, that output at reset can be set in advance.

For details, see "8-4(2) Output at reset."

Also, when the operation modes shown in the next page are assigned to EVENT/DO, EVENT/DO are not output in a reset state.

#### EVENT/DO operation modes that are not output in a reset state

| Type    | Action                               |
|---------|--------------------------------------|
| DEV Hi  | Higher limit deviation               |
| DEV Low | Lower limit deviation                |
| DEV Out | Outside higher/lower limit deviation |

| Type   | Action                              |
|--------|-------------------------------------|
| DEV In | Inside higher/lower limit deviation |
| PV Hi  | PV higher limit absolute value      |
| PV Low | PV lower limit absolute value       |

### 4-3 Program Functions

Up to 20 steps x 20 patterns can be stored to memory on this device. Steps can be freely assigned as long as the total number of steps to assign to each pattern is within 400 steps.

For example, when you have completely used up the steps, set the number of steps allocated to pattern 20 to 0 (20 to 0), and change the number of steps in pattern 1 to 40 (20 to 40) as shown in the following example.

In this case, pattern 20 cannot be used in the program.

|              |    |    |   |
|--------------|----|----|---|
| PTN          | 20 | CH | 1 |
| Num. of STEP | 0  |    |   |
| Start STEP   | 1  |    |   |

|              |    |    |   |
|--------------|----|----|---|
| PTN          | 01 | CH | 1 |
| Num. of STEP | 40 |    |   |
| Start STEP   | 1  |    |   |

2-1

The FP23 is also installed with various program setup functions such as the pattern link function, pattern execution function, and step loop function. The following briefly introduces these functions.

#### ■ Pattern link function

Each of the patterns can be linked. The pattern link can be set in any order. Linking is not performed when the pattern link is set to 0.

|     |               |   |        |
|-----|---------------|---|--------|
| 1-3 | PTN Link Reps | 1 | CH     |
|     | Link Format   | 1 |        |
|     | 1st           | 3 | 3rd: 4 |
|     | 2nd           | 1 | 4th: 6 |

|     |     |   |         |    |
|-----|-----|---|---------|----|
| 1-4 | 5th | 0 | 9th: 0  | CH |
|     | 6th | 0 | 10th: 0 | 1  |
|     | 7th | 0 | 11th: 0 |    |
|     | 8th | 0 | 12th: 0 |    |

|     |      |   |         |    |
|-----|------|---|---------|----|
| 1-5 | 13th | 0 | 17th: 0 | CH |
|     | 14th | 0 | 18th: 0 | 1  |
|     | 15th | 0 | 19th: 0 |    |
|     | 16th | 0 | 20th: 0 |    |

#### ■ Pattern link execution function

Linked patterns can be executed repeatedly 1 to 9999 times.

|     |               |   |        |
|-----|---------------|---|--------|
| 1-3 | PTN Link Reps | 2 | CH     |
|     | Link Format   | 1 |        |
|     | 1st           | 3 | 3rd: 4 |
|     | 2nd           | 1 | 4th: 6 |

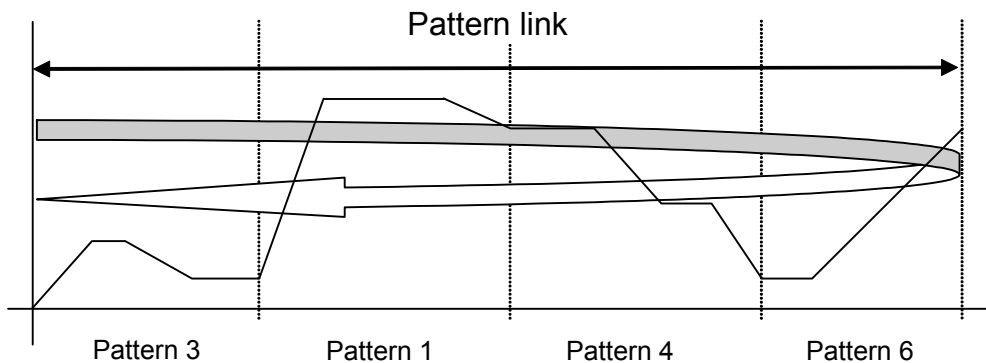

■ **Pattern execution function**

Any pattern can be executed repeatedly 1 to 9999 times

|     |           |     |    |    |
|-----|-----------|-----|----|----|
| 2-2 |           |     |    | Ch |
| PTN |           |     |    | 1  |
| 01  | Start SV: | 0.0 | °C |    |
|     | PTN Repl: |     |    | 2  |

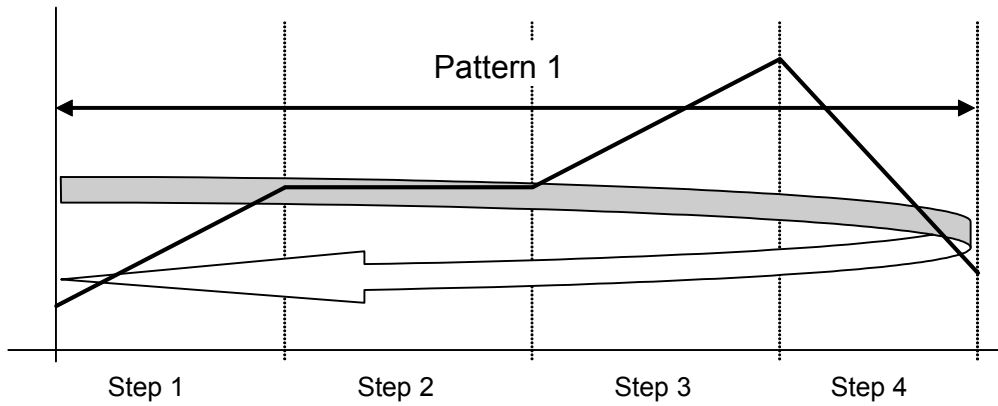

■ **Step loop function**

Any step can be executed repeatedly 1 to 9999 times.

|     |            |   |  |    |
|-----|------------|---|--|----|
| 2-3 |            |   |  | Ch |
| PTN | Loop Setup |   |  | 1  |
| 01  | Start      | 2 |  |    |
|     | End        | 5 |  |    |
|     | Reps       | 2 |  |    |

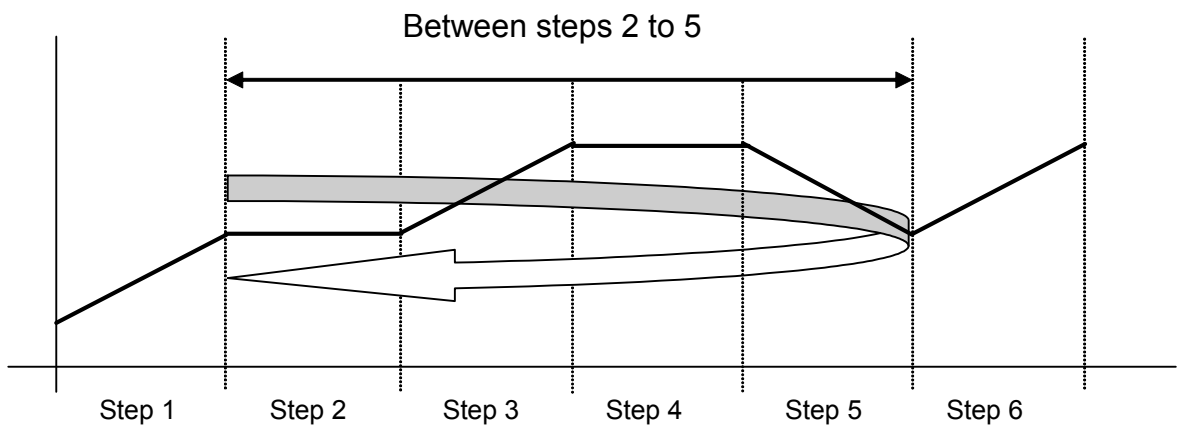

# 4-4 CONTROL FUNCTION BLOCK DIAGRAMS

## (1) 1-input, 1-output/2-output

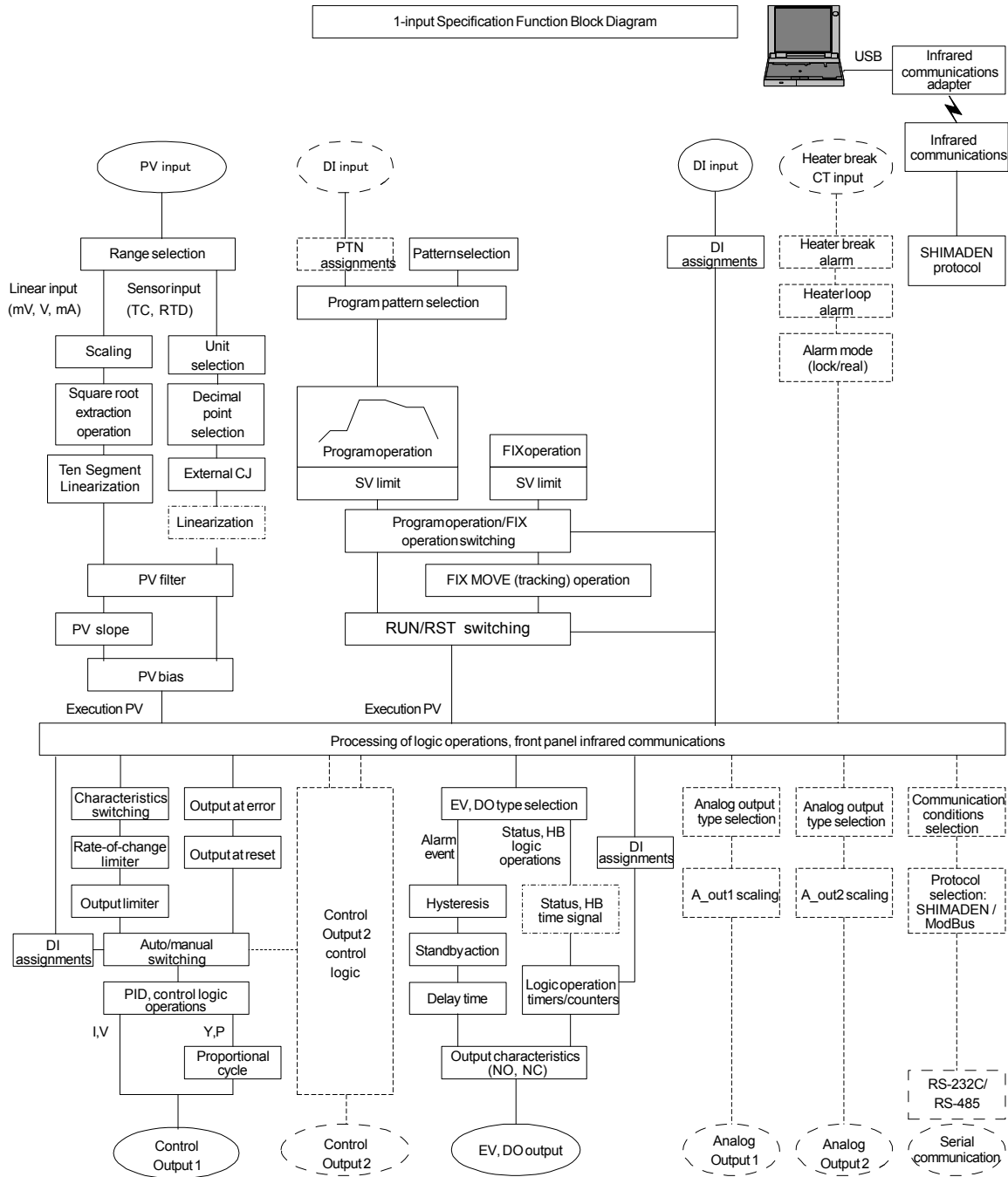

(2) 2-input, 1-output/2-output

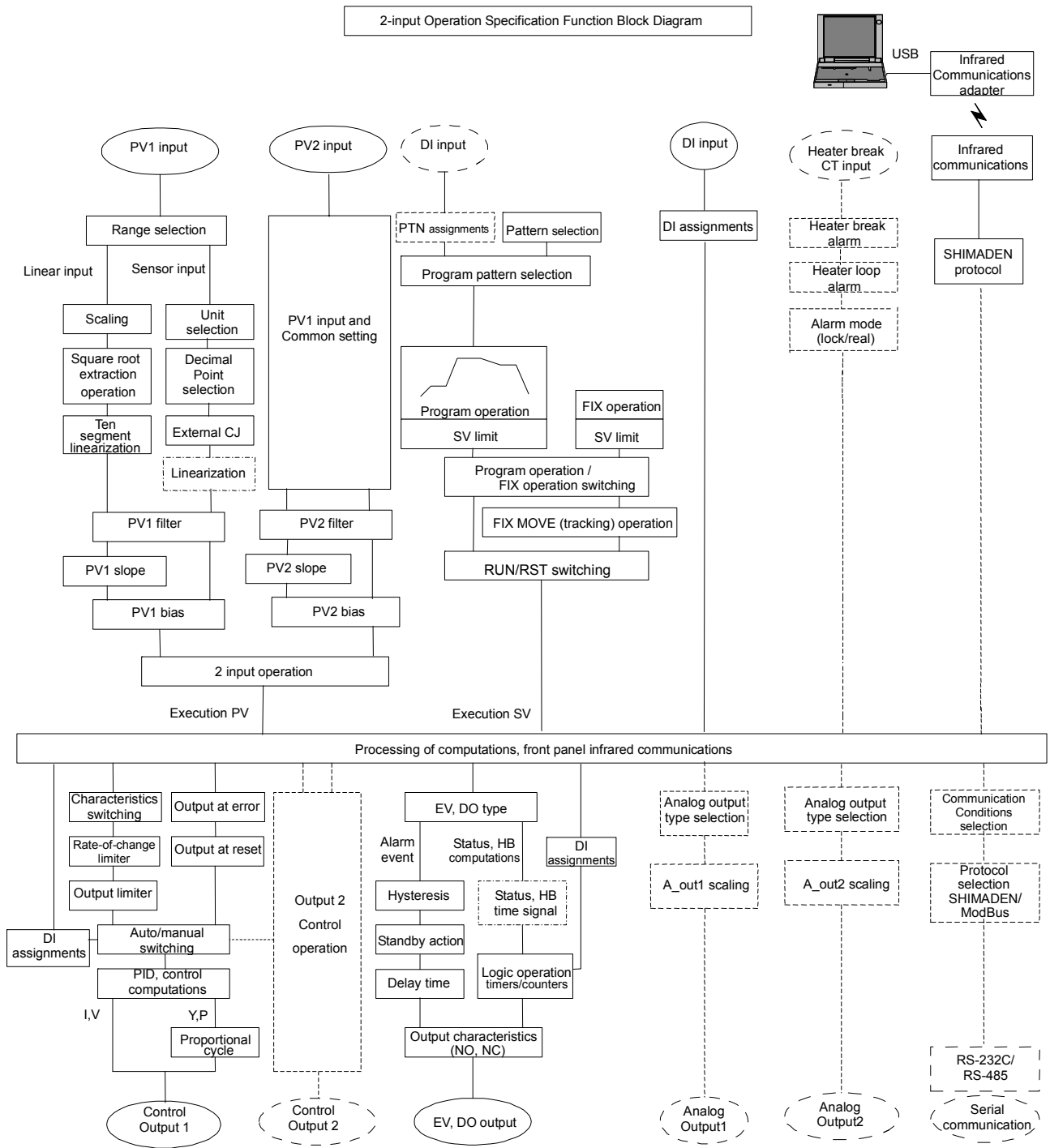

### (3) 2-input, 2-output, Independent 2-channel

2-input, 2-output 2-channel Operation Specification Function Block Diagram

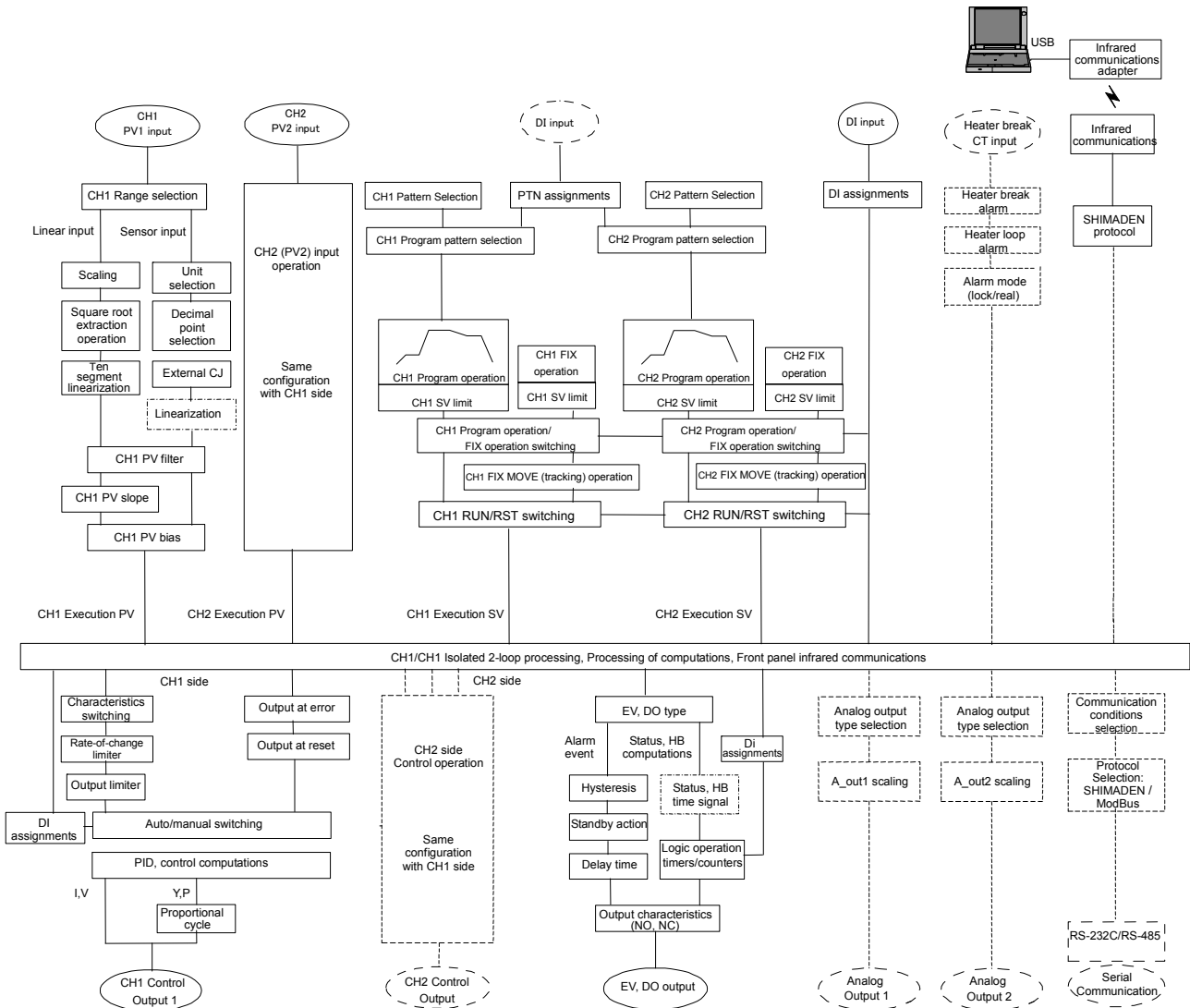

## 5 SETUP

### 5-1 Parameter Setup Procedure

Follow the procedure below to set up this device or change device settings when you use this device for the first time, change the operation parameters during use, or the control target device has been changed, for example.

---

#### Caution

With some operations, when you initialize this device, all parameter settings return to their factory defaults.  
Before you initialize this device, note down and retain settings as required.

---

It is assumed that experienced personnel familiar with basic operation of this device will set up this device.

Users other than device manufacturers should thoroughly familiarize themselves with the functions to be used before they start to operate or set up this device.

Basic operations and setup of this device are described in detail from Chapter 6 onwards by following programming procedures.

Some screens and parameters are not displayed when option functions are not added on or when option functions are not selected.

For an overview of operation screens and how to move between screens, see "LCD Flow Chart" in the preface. For an overview of setup parameters, see "18. List of Parameters."

Set up parameters in the order shown below.

1. Confirm the Output Specification and Release the Key Lock.  
Perform this as necessary.  
For details, see "Chapter 6."
2. I/O Settings  
For details, see "Chapter 7."
3. I/O Auxiliary Settings  
For details, see "Chapter 8."
4. Program Settings  
Make "program initial settings," "step-related settings," "pattern-related settings," "pattern link-related settings," and "settings before program operation."  
For details, see "Chapter 9."
5. FIX Settings  
For details, see "Chapter 10."

- 6. PID Setting**  
For details, see "Chapter 11."
- 7. EVENT & DO Settings**  
For details, see "Chapter 12."
- 8. Option Settings (DI, AO, HB, COM,)**  
For details, see "Chapter 13."
- 9. Key Lock Setting**  
When setup of parameters are completed, set the key lock as necessary to prevent inadvertent operation.  
For details, see "Chapter 14."
- 10. Monitoring, Executing & Stopping Operation**  
For details, see "Chapter 15."
- 11. Operations During Control**  
For details, see "Chapter 16."



## 6 OUTPUT SPECIFICATION & KEY LOCK

Perform the following as necessary.

This controller is delivered with the operation mode(s) (specification(s)) which you specified. However, you may modify the operation mode by making some operations on the screen(s) even after purchase and delivery.

### 6-1 Selection of operation mode under 2-input specification



#### Caution

- ◆ On the 2-input specification model, all parameters will be initialized by the change of operation mode explained in this section. For this reason, configuration of parameters is required after the operation mode is changed.

Here, functions and setup of this device with 2-input operation mode are described. This operation mode is related to the fundamental part of the basic control. Thus, you are requested and advised to make sure you thoroughly understand the contents of this description. Please be aware also that the operation sequence is intentionally made complicated to avoid unnecessary settings and/or changes being made.

#### (1) Operation mode under 2-input, 2-output specification

There are 3 types of 2-input operation modes as follow:

##### ■ 2-input operation (1-loop): DS, DD (Model code)

Make control action with an SV by processing of computation on 2 inputs.

The input operation may be chosen from among 4 methods, i.e. PV Max. value (MAX), PV Min. value (MIN), PV average value (AVE) and PV deviation value (DIV). The result is indicated as PV display.

(1) In 1-output specification, only OUT1 is operable and OUT2 is disabled.

(2) In 2-output specification, this is operated as a controller of 1-loop and 2-output.

Outputs may be combined as follows: Reverse + Reverse, Direct + Direct, Reverse + Direct. Therefore the controller may be used for 2-stage heating/2-stage cooling, heating/cooling, etc.

##### ■ 2-input, 2-output (2-loop): DL (Model code)

This mode is for using the channels (CH1: Input1 - OUT1, CH2: Input 2 – OUT2) as independents. This device works as 2 controllers.

## ■ 1-Input

This device works as an ordinary 1-input (1-loop) controller and Input 2 will be disabled.

- (1) In 1-output specification, only OUT1 is operable, and OUT2 is disabled.
- (2) In 2-output specification, this is operated as a controller of 1-loop and 2-output.  
Outputs may be combined as follows: Reverse + Reverse, Direct + Direct, Reverse + Direct. Therefore the controller may be used for 2-stage heating/2-stage cooling, heating/cooling, etc.

## (2) Setting of Operation Mode under 2-Input Specification

1. Release the key lock if the key is locked.  
For operation for releasing the key lock, see "6-2 Releasing the Key Lock."
2. Put the control action of the controller on reset (RST).  
For using this device under 2-loop specification, put both CH1 and CH2 on reset.  
For details on control reset operation, see "4-1 Control Modes".
3. Access to the operation mode setup screen.  
Call up the top screen of Lock, etc. Screen Group (group 8) from the basic screen by pressing the **GRP** key several times.
4. Now, press the **◀** key for at least 3 seconds by holding the **ENT** key.

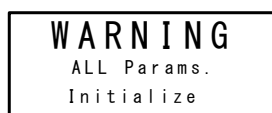
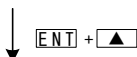
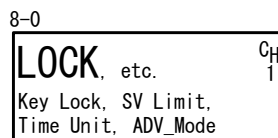

On the LCD screen, a warning will be indicated, and setup parameters in the following table will be displayed on the PV/SV display.

| PV Display<br>SV Display | Operation<br>Mode   | Description  |
|--------------------------|---------------------|--|
| <i>2-1 n<br/>1Loop</i>   | 2-Input<br>(1-loop) | Operates as a 2-input operation controller. This may be used by switching between 1-output and 2-output. |
| <i>2-1 n<br/>2Loop</i>   | 2-Input<br>(2-loop) | Operates as 2 independent controllers.<br>Covers CH1: INPUT1, OUT1 and CH2: INPUT2, OUT2.                |
| <i>1-1 n<br/>1Loop</i>   | 1-Input<br>(1-loop) | Controller with 1 channel, being able to be used by switching between 1-output and 2-output.             |

5. Select operation mode by pressing either the **▼** or **▲** key and confirm the registration by pressing the **ENT** key. This device will restart and resume.  
If you do not want to change the operation mode, go back to the top screen of Lock, etc. Screen Group (group 8) by pressing the **◀** key.

## 6-2 Releasing the Key Lock

### (1) Key lock screen display

To call up the LOCK, etc. screen group (group 8) from the basic screen, press the **GRP** key.

Press the **SCRN** key in the LOCK, etc. screen group to switch to the screens for making and changing setups.

Select parameters in screens by pressing the **↻** key.

Set parameters by pressing the **◀**, **▼** or **▲** key, and press the **ENT** key to fix and register settings.

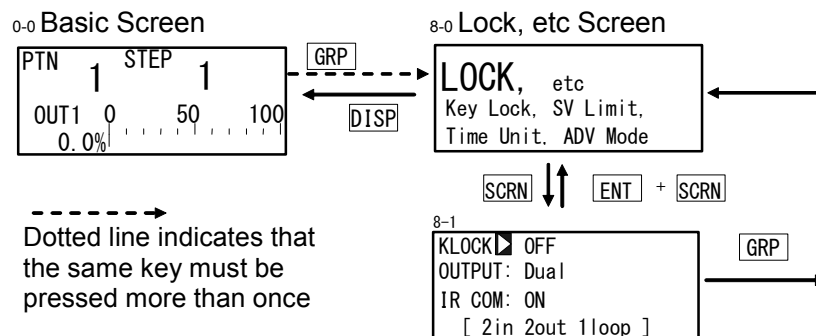

### (2) Releasing the key lock

When the key lock is applied, the **🔒** (key mark) is displayed at the relevant parameter on the LCD screen indicating that the parameter cannot be set or its settings changed. The following shows the procedure for releasing the key lock.

|  |               |                          |
|--|---------------|--------------------------|
| 8-1  | Setting range | OFF, LOCK1, LOCK2, LOCK3 |
| <div style="border: 1px solid black; padding: 5px; width: fit-content;">           KLOCK <b>🔒</b> OFF<br/>           OUTPUT: Dual<br/>           IR COM: ON<br/>           [ 2in 2out 1loop ]         </div> | Initial value | OFF                      |

|       |  |
|-------|--|
| OFF   | Release the key lock   |
| LOCK1 | Locks parameters other than SV related, AT, MAN, or EVENT/DO action points |
| LOCK2 | Locks parameters other than SV related                                     |
| LOCK3 | Locks all parameters (excluding the key lock parameter itself)             |

For details on parameters that are locked, see "18 List of Parameters."

This page left intentionally blank.

## 7 I/O SETTINGS, INFRARED COMMUNICATION

### 7-1 Output Specifications (2-output specification)

When 1-input: 1-output/2-output or 2-input operation: 1-output/2-output is selected, output specification (OUTPUT: Single (1-output)/Dual (2-output)) will be displayed. It will not be displayed in independent 2-channel specification and cascade specification (2-loop control).

For example, when the 2-output specification is changed into a 1-output specification (OUT1), the parameter value of "Dual" is changed into "Single". Control output becomes the output of OUT1 only.

Select the output mode after setting control action to the Reset State.  
For details on operation to stop control, see "4-1 Control Modes."

|  |               |         |
|--|---------------|---------|
| 8-1  | Setting range | ON, OFF |
| KLOCK : OFF<br>OUTPUT <input checked="" type="checkbox"/> Dual<br>IR COM: ON<br>[ 2in 2out 1loop ] | Initial value | ON      |

Single 1-output control action

Only OUT1 is used for control output.

Dual 2-output control action

OUT1 and OUT2 are used for control output.

#### ◆Displaying the current operation mode

The current operation mode is displayed at the bottom line of the key lock and number of outputs setup screen (No. 8-1).

|                |   |
|----------------|---|
| 1in 1out 1loop | : 1-output controller                   |
| 1in 2out 1loop | : 2-output controller                   |
| 2in 1out 1loop | : 2-input operation/1-output controller |
| 2in 2out 1loop | : 2-input operation/2-output controller |
| 2in 2out 2loop | : Independent 2-channel controller      |

## 7-2 Infrared Communication

Allow the infrared communication using S5004 (Infrared Communication Adapter, selling separately). IR COM should be ON before the instrument parameters are set via infrared communication.

Parameter Assistant Software is also used for this communication. For details, see "Parameter Assistant Instruction Manual" which can be accessed from its Help menu.

|     |               |         |
|-----|---------------|---------|
| 8-1 | Setting range | ON, OFF |
|     | Initial value | ON      |

```

KLOCK : OFF
OUTPUT: Dual
IR COM ON
[ 2in 2out 1loop ]

```

ON Infrared communication by S5004 is available.

OFF Infrared communication by S5004 is not available.

## 7-3 Measuring Range

Before performing setup, set control action to Reset State.

For details on operation to stop control, see "4-1 Control Modes."

### (1) Range setting

Set the code No. to RANGE referring to the Measuring Range Code Table below.

In 2-input (1-output/2-output) operation, a single measuring range is assigned for the two inputs.

|     |               |  |
|-----|---------------|--|
| 7-2 | Setting range | 01 to 19, 31 to 58, 71 to 77, 81 to 87 |
|     | Initial value | 06 (K3)                                |

```

7-2
RANGE 06 (K3)
Sc_L 0.0°C
Sc_H 800.0°C
UNIT : °C DP XXXX.X

```

When the range is changed in the above screen, the following confirmation message will be displayed.

Press the  key to select YES, and press the  key to apply the setting.

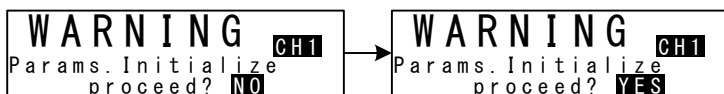

## Caution

- ◆ When the range is changed, the above warning message will be displayed, and parameters will be initialized. For details on parameters that are initialized, see "18 List of Parameters"

**(2) Range scaling**

This item is set during voltage input and current input, and cannot be set during RTD and TC input. Set the measurement range (scaling). Sc\_L is scaling of the lower limit side of PV and Sc\_H is scaling of the higher limit side of PV.

7-2

|                    |            |
|--------------------|------------|
| RANGE: 86 (0~ 10V) | CH         |
| Sc_L: 0.0 %        | 1          |
| Sc_H: 100.0 %      |            |
| UNIT: %            | DP: XXXX.X |

Settable range

-19999 to 30000 digit

Measuring range

Minimum span: 10 digit

Maximum span: 30000 digit

Any setting within the above ranges is possible.

(Note that Sc\_L &lt; Sc\_H)

Initial value

Sc\_L: 0 digit,

Sc\_H: 1000 digit

The maximum span is  $(Sc_H - Sc_L) \leq 30000$ .

When an Sc\_L is set that causes the span to exceed 30000, a value that does not exceed span is automatically set to Sc\_H.

When scaling is changed in the above screen, the following confirmation message will be displayed.

Press the  key to select YES, and press the  key to apply the setting. The range will be changed.

|                    |   |                    |
|--------------------|---|--------------------|
| <b>WARNING</b> CH1 | → | <b>WARNING</b> CH1 |
| Params. Initialize |   | Params. Initialize |
| proceed? NO        |   | proceed? YES       |

---

## Caution

- ◆ When the range is scaled, the above warning message will be displayed, and parameters will be initialized. For details on parameters that are initialized, see "18 List of Parameters."
-

## ■ Measuring Range Code Table

| Input Type      | Sensor Type   | Code                  | Symbol  | Measuring range      | Measuring range     |                     |
|-----------------|---------------|-----------------------|---------|----------------------|---------------------|---------------------|
| Universal Input | Thermo-couple | B *1                  | 01      | B                    | 0.0 to 1800.0 °C    | 0 to 3300 °F        |
|                 |               | R                     | 02      | R                    | 0.0 to 1700.0 °C    | 0 to 3100 °F        |
|                 |               | S                     | 03      | S                    | 0.0 to 1700.0 °C    | 0 to 3100 °F        |
|                 |               | K                     | 04      | K1                   | -100.0 to 400.0 °C  | -150.0 to 750.0 °F  |
|                 |               | K                     | 05      | K2                   | 0.0 to 400.0 °C     | 0.0 to 750.0 °F     |
|                 |               | K                     | 06      | K3                   | 0.0 to 800.0 °C     | 0.0 to 1500.0 °F    |
|                 |               | K                     | 07      | K4                   | 0.0 to 1370.0 °C    | 0.0 to 2500.0 °F    |
|                 |               | K *2                  | 08      | K5                   | -200.0 to 200.0 °C  | -300.0 to 400.0 °F  |
|                 |               | E                     | 09      | E                    | 0.0 to 700.0 °C     | 0.0 to 1300.0 °F    |
|                 |               | J                     | 10      | J                    | 0.0 to 600.0 °C     | 0.0 to 1100.0 °F    |
|                 |               | T *2                  | 11      | T                    | -200.0 to 200.0 °C  | -300.0 to 400.0 °F  |
|                 |               | N                     | 12      | N                    | 0.0 to 1300.0 °C    | 0.0 to 2300.0 °F    |
|                 |               | PL II                 | 13      | PLII                 | 0.0 to 1300.0 °C    | 0.0 to 2300.0 °F    |
|                 |               | PR40-20 *3            | 14      | PR40-20              | 0.0 to 1800.0 °C    | 0 to 3300 °F        |
|                 |               | WRe5-26               | 15      | WRe5-26              | 0.0 to 2300.0 °C    | 0 to 4200 °F        |
|                 |               | U                     | 16      | U                    | -200.0 to 200.0 °C  | -300.0 to 400.0 °F  |
|                 |               | L                     | 17      | L                    | 0.0 to 600.0 °C     | 0.0 to 1100.0 °F    |
|                 |               | K *4                  | 18      | K                    | 10.0 to 350.0 K     | 10.0 to 350.0 K     |
|                 |               | AuFe-Cr *5            | 19      | AuFe-Cr              | 0.0 to 350.0 K      | 0.0 to 350.0 K      |
|                 | RTD           | Pt100<br>(new)JIS/IEC | 31      | Pt 1                 | -200.0 to 600.0 °C  | -300.0 to 1100.0 °F |
| 32              |               |                       | Pt 2    | -100.00 to 100.00 °C | -150.0 to 200.0 °F  |                     |
| 33              |               |                       | Pt 3    | -100.0 to 300.0 °C   | -150.0 to 600.0 °F  |                     |
| 34              |               |                       | Pt 4    | -60.00 to 40.00 °C   | -80.00 to 100.00 °F |                     |
| 35              |               |                       | Pt 5    | -50.00 to 50.00 °C   | -60.00 to 120.00 °F |                     |
| 36              |               |                       | Pt 6    | -40.00 to 60.00 °C   | -40.00 to 140.00 °F |                     |
| 37              |               |                       | Pt 7    | -20.00 to 80.00 °C   | 0.00 to 180.00 °F   |                     |
| 38              |               |                       | Pt 8 *6 | 0.000 to 30.000 °C   | 0.00 to 80.00 °F    |                     |
| 39              |               |                       | Pt 9    | 0.00 to 50.00 °C     | 0.00 to 120.00 °F   |                     |
| 40              |               |                       | Pt10    | 0.00 to 100.00 °C    | 0.00 to 200.00 °F   |                     |
| 41              |               |                       | Pt11    | 0.00 to 200.00 °C    | 0.0 to 400.0 °F     |                     |
| 42              |               |                       | Pt12 *7 | 0.00 to 300.00 °C    | 0.0 to 600.0 °F     |                     |
| 43              |               |                       | Pt13    | 0.0 to 300.0 °C      | 0.0 to 600.0 °F     |                     |
| 44              |               |                       | Pt14    | 0.0 to 500.0 °C      | 0.0 to 1000.0 °F    |                     |



| Input Type  | Sensor Type                   | Code        | Symbol         | Measuring range   | Measuring range     |
|---|-------------------------------|-------------|----------------|---|---------------------|
| Universal Input   | RTD<br>Pt100<br>(old) JIS/IEC | 45          | JPt 1          | -200.0 to 500.0 °C  | -300.0 to 900.0 °F  |
|   |                               | 46          | JPt 2          | -100.00 to 100.00 °C  | -150.0 to 200.0 °F  |
|   |                               | 47          | JPt 3          | -100.0 to 300.0 °C  | -150.0 to 600.0 °F  |
|   |                               | 48          | JPt 4          | -60.00 to 40.00 °C  | -80.00 to 100.00 °F |
|   |                               | 49          | JPt 5          | -50.00 to 50.00 °C  | -60.00 to 120.00 °F |
|   |                               | 50          | JPt 6          | -40.00 to 60.00 °C  | -40.00 to 140.00 °F |
|   |                               | 51          | JPt 7          | -20.00 to 80.00 °C  | 0.00 to 180.00 °F   |
|   |                               | 52          | JPt 8 *6       | 0.000 to 30.000 °C  | 0.00 to 80.00 °F    |
|   |                               | 53          | JPt 9          | 0.00 to 50.00 °C  | 0.00 to 120.00 °F   |
|   |                               | 54          | JPt10          | 0.00 to 100.00 °C   | 0.00 to 200.00 °F   |
|   |                               | 55          | JPt11          | 0.00 to 200.00 °C   | 0.0 to 400.0 °F     |
|   |                               | 56          | JPt12 *7       | 0.00 to 300.00 °C   | 0.0 to 600.0 °F     |
|   |                               | 57          | JPt13          | 0.0 to 300.0 °C   | 0.0 to 600.0 °F     |
|   |                               | 58          | JPt14          | 0.0 to 500.0 °C   | 0.0 to 900.0 °F     |
| Voltage<br>(mV)   | -10 to 10 mV                  | 71          | -10 to 10 mV   | Initial value : 0.0 to 100.0<br>Measuring range : Any value in the following ranges can be set by the scaling function.<br>Scaling range : -19999 to 30000 digit<br>Span : 10 to 30000 digit<br>Scale over occurs when the input measured value exceeds 32000.<br><br>When used with 0 to 20 mA, 4 to 20 mA current input, select either of measuring range codes 84 and 85, and attach a shunt resistor of 1/2W, 250Ω±0.1% to the input terminals. |                     |
|   | 0 to 10 mV                    | 72          | 0 to 10 mV     |   |                     |
|   | 0 to 20 mV                    | 73          | 0 to 20 mV     |   |                     |
|   | 0 to 50 mV                    | 74          | 0 to 50 mV     |   |                     |
|   | 10 to 50 mV                   | 75          | 10 to 50 mV    |   |                     |
|   | 0 to 100 mV                   | 76          | 0 to 100 mV    |   |                     |
|   | -100 to 100 mV                | 77          | -100 to 100 mV |   |                     |
|   | Voltage<br>(V)                | -1 to 1 V   | 81             |   | -1 to 1 V           |
|   |                               | 0 to 1 V    | 82             |   | 0 to 1 V            |
|   |                               | 0 to 2 V    | 83             |   | 0 to 2 V            |
|   |                               | 0 to 5 V    | 84             |   | 0 to 5 V            |
|   |                               | 1 to 5 V    | 85             |   | 1 to 5 V            |
|   |                               | 0 to 10 V   | 86             |   | 0 to 10 V           |
| -10 to 10 V   | 87                            | -10 to 10 V |                |   |                     |
| <p>*1 : The accuracy of thermocouple B is not guaranteed at temperatures 400°C and 750°F or below.</p> <p>*2 : Accuracy at temperatures -100°C (-148°F) or below ±(0.5%FS+1 digit).</p> <p>*3 : Accuracy is ±(0.3%FS+1°C).</p> <p>*4 : The accuracy of thermocouple K is ±(0.75%FS+1K)/10.0 to 30.0K, ±(0.30%FS+1K)/30.0 to 70.0K, ±(0.25%FS+1K)/70.0 to 350.0K.</p> <p>*5 : The accuracy of thermocouple AuFe-Cr is ±(0.25%FS+1K).</p> <p>*6 : The higher limit side scale over occurs when the input measured value exceeds 32.000.</p> <p>*7 : The higher limit side scale over occurs when the input measured value exceeds 320.00.</p> |                               |             |                |   |                     |

## 7-4 Unit

Set the measurement unit.

7-2

|                    |            |
|--------------------|------------|
| RANGE: 86 (0~ 10V) | CH         |
| Sc_L: 0.0%         | 1          |
| Sc_H: 100.0%       |            |
| UNIT: %            | DP: XXXX.X |

RTD, TC

Setting range °C, °F

Initial value °C

Voltage, Current

Setting range °C, °F, %, None

Initial value %

Only temperature (°C or °F) can be selected for RTD or TC input.

When the unit is changed in the above screen, the following confirmation message will be displayed at TC and RTD input. At voltage or current input, this warning message will not be displayed.

Press the  key to select YES, and press the  key to apply the setting. The unit will be changed.

|  |   |   |
|--|---|---|
| <b>WARNING</b> CH1<br>Params. Initialize<br>proceed? <b>NO</b> | → | <b>WARNING</b> CH1<br>Params. Initialize<br>proceed? <b>YES</b> |
|--|---|---|

### Caution

- ◆ When the unit is changed, the above warning message will be displayed, and parameters will be initialized. For details on parameters that are initialized, see "18 List of Parameters."

## 7-5 Decimal Point Position

### (1) Decimal point position

This item can be set during voltage input, and cannot be set during RTD and TC input. Set the decimal point position for PV display.

7-2

|                      |            |
|----------------------|------------|
| RANGE: 71 (-10~10mV) | CH         |
| Sc_I: 0.0%           | 1          |
| Sc_H: 100.0%         |            |
| UNIT: %              | DPI XXXX.X |

Setting range      xxxx.x to x.xxxx  
Initial value        xxxx.x

### (2) Switching the lowest digit past the decimal point

The lowest digit past the decimal point of measuring ranges determined by the range setting can be set.

Note, however, that this function cannot be used for measurement ranges without digits past the decimal point.

This screen is not displayed in the case of voltage input and current input.

7-3

|                |    |
|----------------|----|
| Figure: Normal | CH |
| CJ: Internal   | 1  |

Setting range      Normal, Short  
Initial value        Normal

When "Figure" is changed in the above screen, the following confirmation message will be displayed.

Press the  key to select YES, and press the  key to apply the setting. "Figure" will be changed.

|  |   |   |
|--|---|---|
| <b>WARNING</b> CH1<br>Params. Initialize<br>proceed? <b>NO</b> | → | <b>WARNING</b> CH1<br>Params. Initialize<br>proceed? <b>YES</b> |
|--|---|---|

## Caution

- ◆ When the lowest digit is changed, the above warning message will be displayed, and parameters will be initialized. For details on parameters that are initialized, see "18 List of Parameters."

## 7-6 Cold Junction Compensation

### (1) Thermocouple cold junction compensation

Set whether to perform cold junction compensation during TC input internally or externally.

Normally, set to internal compensation. Set to external compensation when greater accuracy is required.



Setting range

Internal, External

Initial value

Internal

# 8 I/O AUXILIARY SETTINGS

## 8-1 Setup of 2-Input Operation

This is setup under 2-Input Operation Specification (1-loop).

This is a function for making operations for obtaining deviation, maximum, minimum, average, etc., between 2 inputs and then places the results in PV value.

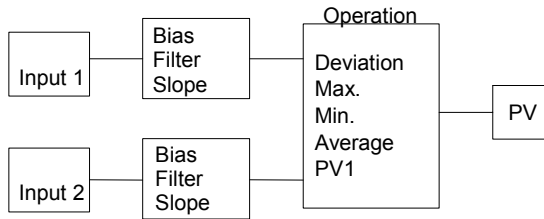

In the setting only for 2-input operation specification, set operation and process for scaleover.

This may also process bias, filter and slope for each of 2 inputs before processing computing operation.

### (1) Selection of PV Mode

This is the 2-input operation setting screen.

Select the operation method for obtaining PV value to be used in control action.

This operation is to be conducted after putting the control action on reset state.

7-1

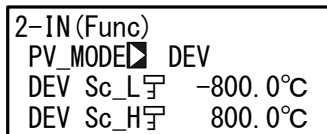

Setting range

MAX, MIN, AVE, DEV, PV

Initial value

DEV

|     |                 |  |
|-----|-----------------|--|
| MAX | Max. value      | Use larger input value as PV value.  |
| MIN | Min. value      | Use smaller input value as PV value.   |
| AVE | Average value   | Use average value of input values as PV value.                                       |
| DEV | Deviation value | Use (Input 1 - Input 2) as PV value.   |
| PV  |                 | Use PV1 (after making computation of Bias, Filter and Slope of Input 1) as PV value. |

### (2) Process when scaleover occurs

Set process to be taken when any PV scaleover occurs in 2-input operation.

This parameter may not be set when PV\_MODE is set to DEV or PV.

7-1

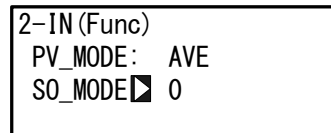

Setting range

0, 1

Initial value

0

- 0 Proceed with control action with a PV value falling within the scale range if an input falls to scaleover, but the other input is within the scale. This is applicable only if MAX, MIN or AVE is selected.
- 1 If any inputs fall to scaleover, follow the scaleover process set in this setting procedure.

**(3) Bias, filter and slope**

Set bias, filter and slope for each of inputs 1 and 2.

7-3

|                 |
|-----------------|
| INPUT1          |
| PV Bias ▣ 0.0   |
| PV Filter: OFF  |
| PV Slope: 1.000 |

7-4

|                 |
|-----------------|
| INPUT2          |
| PV Bias ▣ 0.0   |
| PV Filter: OFF  |
| PV Slope: 1.000 |

For details, see “8-2 PV compensation value”.

**8-2 PV Compensation Value**

**(1) PV bias**

This item is used to compensate for error in the indicated temperature, for example, in the sensor/connected peripherals.

7-1

|                 |    |
|-----------------|----|
| PV Bias ▣ 0.0   | CH |
| PV Filter: OFF  | 1  |
| PV Slope: 1.000 |    |

Setting range      -10000 to 10000 digit  
Initial value        0 digit

**(2) PV filter**

When the PV signal contains noise, the control result sometimes is adversely affected by fluctuation of PV signals.

The PV filter is used to decrease this influence and stabilize control.

7-1

|                 |    |
|-----------------|----|
| PV Bias: 0.0    | CH |
| PV Filter ▣ OFF | 1  |
| PV Slope: 1.000 |    |

Setting range      OFF, 1 to 100 s  
Initial value        OFF

PV filtering is performed by First Order Lag computation.

The filter time constant can be set up to 100 seconds.

When a large time constant is set, noise removal performance increases. However, in control systems having a fast response, noise removal is adversely affected.

**(3) PV slope**

This item sets the PV slope during voltage input and current input.

The screen is not displayed during RTD and TC input.

7-1

|                  |    |
|------------------|----|
| PV Bias: 0.0     | CH |
| PV Filter: OFF   | 1  |
| PV Slope ▣ 1.000 |    |

Setting range      0.500 to 1.500  
Initial value        1.000

Execution  $PV = A \times X + B$       where, A=PV input, X=PV slope, B=Bias

When this item is used in combination with square root extraction operation and linearizer approximation, this slope is applied to the result of square root extraction operation and linearizer approximation.

### 8-3 Square Root Extraction Operation

Signals having square root characteristics such as in the measurement of flow rates can be linearized.

This item is set during voltage input and current input.

This item is not displayed in the case of RTD or TC input.

#### (1) Enabling the square root extraction operation

The square root extraction operation function is valid when SQ.Root is set to ON.

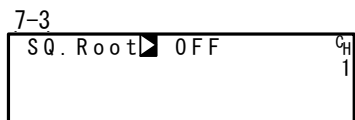

Setting range ON, OFF  
Initial value OFF

#### (2) Low cut

This item functions only when the square root extraction operation function is enabled. Low cut processing is performed on the input before square root extraction operation is performed.



Setting range 0.0 to 5.0%  
Initial value 1.0%

In square root operation, the PV fluctuates greatly by a slight fluctuation of the input value in the vicinity of signal zero.

"Low cut" is a function for outputting "0" (zero) to PV at the preset input value or lower.

Setting low cut prevents action from becoming unstable when there is noise on the input signal line.

The set value of low cut is 0.0 to 5.0% of the PV input range.

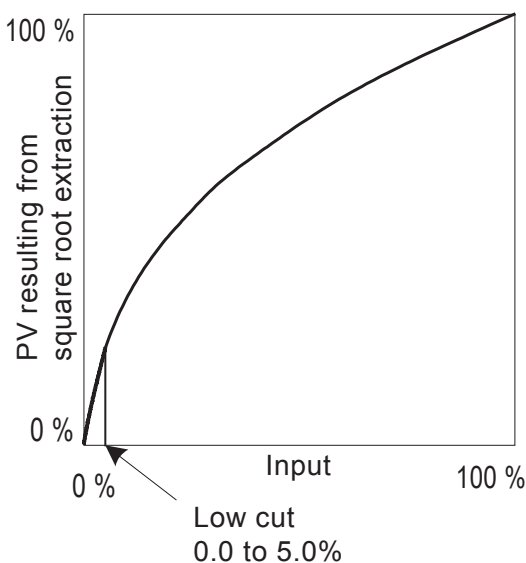

## 8-4 Control Output

### (1) Action characteristics

Select either reverse action (heating specifications) or direct action (cooling specifications) as the output characteristics.

|     |      |     |         |
|-----|------|-----|---------|
| 6-1 | OUT1 | ACT | Reverse |
|     |      | RST | 0.0%    |
|     |      | ERR | 0.0%    |
|     |      | CYC | 30s     |

Setting range      Reverse, Direct  
Initial value      Reverse

**Reverse**      By this action, the smaller the measured value (PV) than the set value (SV), the higher the output.

This action is generally used for heating control.

**Direct**      By this action, the larger the measured value (PV) than the set value (SV), the higher the output.

This action is generally used for cooling control.

#### Note

- ♦ Output characteristics cannot be switched during execution of auto tuning (AT).

### (2) Output at reset

Use this item to maintain control output at a fixed value in a reset state.

|     |      |     |         |
|-----|------|-----|---------|
| 6-1 | OUT1 | ACT | Reverse |
|     |      | RST | 0.0%    |
|     |      | ERR | 0.0%    |
|     |      | CYC | 30s     |

Setting range      0.0 to 100.0%  
Initial value      0.0%

#### Note

- ♦ In ON-OFF control (P=OFF), when output at reset is set to 50% or more, the actual output at reset becomes 100%.  
When output at reset is set to 49.9% or less, the actual output at error becomes 0%.
- ♦ Output at reset is maintained without being affected by whether or not an error has occurred.

### (3) Output at error

Set the value to be output when an error occurs.

|     |      |     |         |
|-----|------|-----|---------|
| 6-1 | OUT1 | ACT | Reverse |
|     |      | RST | 0.0%    |
|     |      | ERR | 0.0%    |
|     |      | CYC | 30s     |

Setting range      0.0 to 100.0%  
Initial value      0.0%

#### Note

- ♦ In ON-OFF control (P=OFF), when output at error is set to 50% or more, the actual output at reset becomes 100%.  
When output at reset is set to 49.9% or less, the actual output at error becomes 0%.
- ♦ Output at reset is given priority when an error has occurred at Reset State.



**(4) Proportional cycle time**

Set the proportional cycle time.

This setting item is for the contact and SSR drive voltage output specification.

The screen is not displayed in the case of the current and voltage output specification.

|      |              |
|------|--------------|
| 6-1  |              |
| OUT1 | ACT: Reverse |
|      | RST: 0.0%    |
|      | ERR: 0.0%    |
|      | CYC: 30s     |

|               |   |
|---------------|---|
| Setting range | 1 to 120s   |
| Initial value | 30s: Contact output (Y)<br>3s: SSR drive output (P) |

**Note**

- ◆ If a short time is set as the proportional cycle time in contact output, the contact life of the output relay may be adversely affected.  
Pay particular attention to this point when setting the proportional cycle time.
- ◆ If a long time is set as the proportional cycle time in a control system with a short delay time, the control result will be adversely affected.
- ◆ The proportional cycle time cannot be set during execution of auto tuning (AT) or ramp control action.

**(5) Setting output 2**

This setting item is available only when the 2-output specification is selected, and is not displayed for a 1-output specification.

The setup method and cautions for parameters are the same as those for Output 1.

|      |              |
|------|--------------|
| 6-1  |              |
| OUT2 | ACT: Reverse |
|      | RST: 0.0%    |
|      | ERR: 0.0%    |
|      | CYC: 30s     |

|     | Setting range    | Initial value                                     |
|-----|------------------|---|
| ACT | :Reverse, Direct | Direct (in 1-loop)<br>Reverse (in 2-loop)         |
| RST | :0.0 to 100.0%   | 0.0%  |
| ERR | :0.0 to 100.0%   | 0.0%  |
| CYC | :1 to 120s       | Contact output (Y) 30s<br>SSR drive output (P) 3s |

**8-5 Setting the Ten-Segment Linearizer Approximation****(1) Enabling ten-segment linearizer approximation**

This function performs linearization based upon ten-segment approximation when the PV input is a non-linear signal.

This item is set during voltage input and current input.

The screen is not displayed during RTD and TC input.

|     |         |
|-----|---------|
| 7-4 |         |
| PMD | OFF     |
|     | CH<br>1 |

|               |         |
|---------------|---------|
| Setting range | ON, OFF |
| Initial value | OFF     |

**(2) Setting input points**

Set the input points in the case of ten-segment linearizer approximation input. Set PV display value (B) to PV input value (A).  
 When the value of B is smaller than the value of the previous A, values of B from then onwards are invalid.

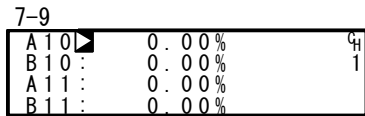
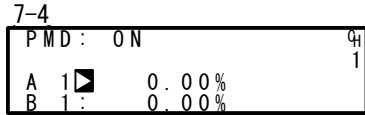

Up to 11 points can be set. 11 points (B1 to B11) can be set for PV display (%) on PV 11 inputs (A1 to A11). For each input point, B1 is set to A1, B2 for A2 and so forth until B11 is set to A11, and linear interpolation is executed between input points.

This item is set during voltage input and current input. The screen is not displayed during RTD and TC input.

Setting range      An, Bn: -5.00 to 105.00%  
 Initial value      An, Bn: 0.00%

**■ Ten-segment linearizer setting (example)**

In the following figure, A1, B1 to A6, B6 are used to set input points with four intermediate points.

For before A1 and from A6 onwards, the ramps of (A1, B1) to (A2, B2) and the ramps of (A5, B5) to (A6, B6) are applied.

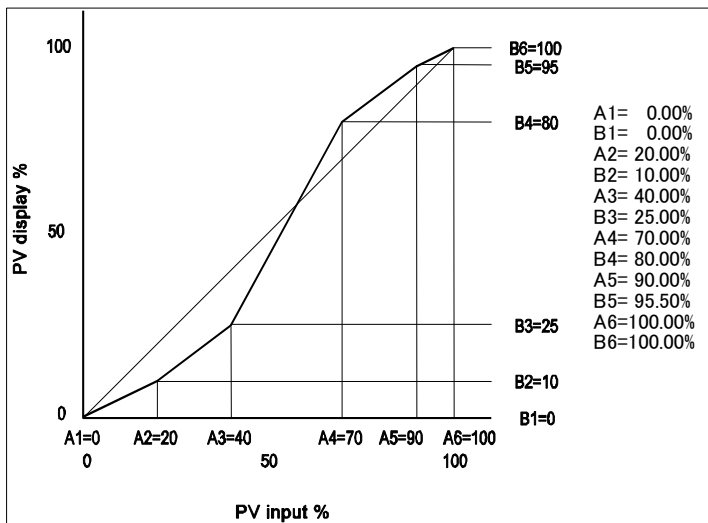

**Caution**

- ◆ Set so that the relationship  $A_n < A_{(n+1)}$  is satisfied. When the relationship becomes  $A_n \geq A_{(n+1)}$ ,  $A_{(n+1)}$  onwards becomes invalid.

## 8-6 Limiters

### (1) Output rate-of-change limiter

Set this setting item when a control target that is adverse to sudden changes in output is used.

The rate-of-change limiter can be set to each of Output 1 (OUT1) and Output 2 (OUT2 is displayed only in the 2-output specification device).

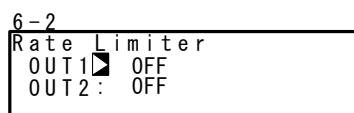

Setting range

OUT1, OUT2: OFF, 0.1 to 100.0 %/s

Initial value

OUT1, OUT2: OFF

### (2) SV limiter

The SV limit is used to prevent a wrongful setting. Set the lower limit value and higher limit value of the SV value setting range.

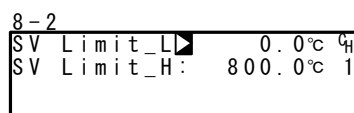

Setting range

Within measuring range  
(SV Limit L < SV Limit H)

Initial value

SV Limit\_L Lower limit value of measuring range

SV Limit\_H Higher limit value of measuring range

If the preset SV value (FIX SV, Start SV, STEP SV) exceeds the SV limit, the SV value will be displayed inverted in white as shown below, and the SV value will be replaced internally with the limiter value, and the limit-cut SV value will be displayed on the SV display.

**Ex) When FIX SV value is set to 400.0°C with RANGE 04(K1) –100.0 to 400.0°C, and then SV Limit\_H is set to 350.0°C**

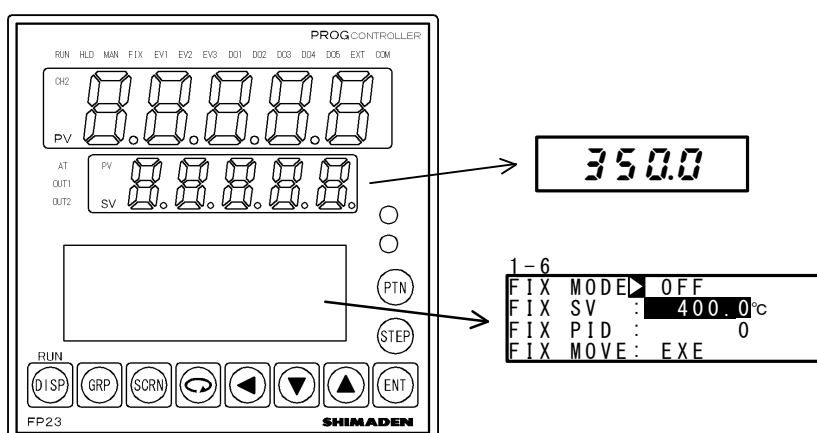

The white-inverted section indicates limiter over.

### 8-7 Compensating Control Output/Analog Output

Error that occurs in control output (at linear output) or analog output can be compensated.

1. Release the key lock if it is applied.  
For details on how to release the key lock, see "6-2 Releasing the Key Lock."
2. Set controller control action to the stop mode (reset).  
In 2-loop specification, both of the CH1 and CH2 should be set to reset state.  
For details on control stop operation, see "4-1 Control Modes."

3. Set the count value.  
Call up the LOCK, etc. top screen (group 8) from the basic screen by the **GRP** key.

Move to the setup screen by holding down the **ENT** key and pressing the **GRP** key for at least 3 seconds, and select the output to compensate by pressing the **SCRN** and **↺** keys. Set the count value currently displayed on the SV display with the **▼** or **▲** key, and press the **ENT** key to fix and register settings.

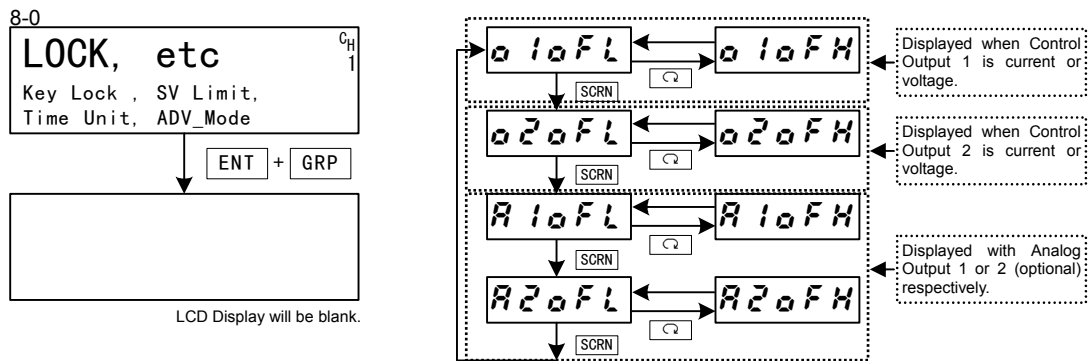

| PV Display   | Description                        | PV Display   | Description                         |
|--------------|------------------------------------|--------------|-------------------------------------|
| <i>o1oFL</i> | Control Output 1 lower limit value | <i>o1oFH</i> | Control Output 1 higher limit value |
| <i>o2oFL</i> | Control Output 2 lower limit value | <i>o2oFH</i> | Control Output 2 higher limit value |
| <i>A1oFL</i> | Analog Output 1 lower limit value  | <i>A1oFH</i> | Analog Output 1 higher limit value  |
| <i>A2oFL</i> | Analog Output 2 lower limit value  | <i>A2oFH</i> | Analog Output 2 higher limit value  |

When "0" is set, settings return to factory defaults.

4. When you have finished setting the above, press the **DISP** key to return to the LOCK, etc. screen.

## 9 PROGRAM SETTINGS

### 9-1 Program Initial Settings

#### (1) Time unit

Set the unit of time that is currently used in various items such as step time or time signal. Set control action to Reset State before performing this operation.

|           |   |        |    |
|-----------|---|--------|----|
| 8-3       |   |        |    |
| Time Unit | ▾ | H/M    | CH |
| PRG. Wait | : | 00h00m | 1  |
| SO Mode   | : | HLD    |    |
| POWER ON  | : | RESET  |    |

Setting range H/M, M/S

Initial value H/M

H/M hours/minutes  
M/S minutes/seconds

#### (2) Program start delay time

The delay time until start of program control execution can be set. The time unit is fixed to H/M.

The RUN lamp blinks for that duration that the delay time is active after program control execution is started.

Program control is started, and the RUN lamp lights after the preset delay time has elapsed.

|           |   |        |    |
|-----------|---|--------|----|
| 8-3       |   |        |    |
| Time Unit | : | H/M    | CH |
| PRG. Wait | ▾ | 00h00m | 1  |
| SO Mode   | : | HLD    |    |
| POWER ON  | : | RESET  |    |

Setting range 00h00m to 99h59m

Initial value 00h00m

#### (3) Input error mode

Set processing when a sensor breaks or a scale over or other error occurs during program control.

|           |   |        |    |
|-----------|---|--------|----|
| 8-3       |   |        |    |
| Time Unit | : | H/M    | CH |
| PRG. Wait | : | 00h00m | 1  |
| SO Mode   | ▾ | HLD    |    |
| POWER ON  | : | RESET  |    |

Setting range HLD, RUN, RESET

Initial value HLD

**HLD** Sets a hold state until the device is restored from scale over or a reset is performed. Note, however, that this differs from a regular hold state in that the setting value of the output at error continues to be output. For details, see "8-4 (3) Output at error."

**RUN** Program action continues until the end of the program or a reset is input. Note, however, that this differs from a regular RUN state in that the setting value of the output at error continues to be output. For details, see "8-4 (3) Output at error."

**RESET** Releases and resets program operation.

**(4) Power failure compensation**

Set in which state of the device is to be restored when the power is turned ON again after a power failure during program execution.

|     |   |               |                 |
|-----|---|---------------|-----------------|
| 8-3 | Time Unit: H/M                                      | Setting range | RESET, CONTINUE |
|     | PRG. Wait: 00h00m                                   | Initial value | RESET           |
|     | SO Mode: HLD  |               |                 |
|     | POWER ON: <input checked="" type="checkbox"/> RESET |               |                 |

- RESET** During Program control, the state that was active before the power fail is not held, and the device is reset when the power is turned ON again.
- CONTINUE** During Program control, the state that was active before the power interrupt is held. (During FIX control, the state that was active before the power interrupt is held at all times.)  
Excluding the following:
1. AT execution
  2. Change in state of DI input
  3. PID No. when the hysteresis of zone PID is taken into consideration

**(5) Advance mode**

Set the details of advance operation.

For details on advance operation, refer to "16-5 Executing Advance (ADV)

|     |  |               |            |
|-----|--|---------------|------------|
| 8-4 | ADV Mode: <input checked="" type="checkbox"/> Step | Setting range | Step, Time |
|     | ADV Time: 00h00m                                   | Initial value | Step       |

- Step** Advances the program by steps.
- Time** Advances the program by time.  
When there is a part that exceeds the step width time in the time set here, that part becomes invalid, and the program advances to the start of the next step immediately when the step width time is exceeded.

**(6) Advance time**

Set the advance time when the advance mode is set to [Time].

|     |  |               |                |
|-----|--|---------------|----------------|
| 8-4 | ADV Mode: Time                                       | Setting range | 00:00 to 99:59 |
|     | ADV Time: <input checked="" type="checkbox"/> 00h00m | Initial value | 00:00          |

**Note**

- ◆ When "00:00" is set, time advance does not function.

**(7) CH1 pattern number**

Set the pattern number of CH1.

The rest of the patterns are assigned to CH2 automatically.

This screen is displayed in 2-input, 2-loop specification.

This parameter setting should be done after the control operation mode is set to RST.

```

8-5
CH1 PTN 10 / 20
  
```

Setting range 0 to 20  
Initial value 10

**Note**

- ◆ When this parameter value is changed, settings for patterns/steps are initialized. For example, if the pattern number of CH1 is changed from 10 (of 20) to 5 (of 20), then reconfigure the number to 10 (of 20), and the pattern 6 to 10 setting will all be initialized.
- ◆ The step numbers that can be assigned for each channel are pattern numbers x 20 steps.

**9-2 Step-related Settings**

Make settings for each step.

The following describes setup operation using start pattern 1 and step 1 as an example.

**(1) Step SV value**

Set the SV value of step 1.

```

2S-1
PTN SV 0.0°C CH1
STEP Time: 00h01m
001 PID: 0
  
```

Setting range Within SV limiter setting range  
Initial value 0.0

**Note**

```

2S-1
PTN SV 400.0°C CH1
STEP Time: 00h00m
001 PID: 0
  
```

- ◆ When the STEP SV value exceeds the limit, the SV value is highlighted as shown left side.
- ◆ The SV value displayed reversed in white is replaced internally with the limiter value, and the SV value cut by the limiter is displayed on the SV display.
- ◆ For details, see "8-6 (2) SV limiter."

**(2) Step Time**

Set the time of step 1.

|      |       |        |
|------|-------|--------|
| 2S-1 |       | CH     |
| PTN  |       | 1      |
| 01   | SV :  | 0.0°C  |
| STEP | Time: | 00h01m |
| 001  | PID : | 0      |

Setting range 00:00 to 99:59

Initial value 00:01

**(3) Step PID No.**

Set the PID No. of step 1 execution.

|      |       |        |
|------|-------|--------|
| 2S-1 |       | CH     |
| PTN  |       | 1      |
| 01   | SV :  | 0.0°C  |
| STEP | Time: | 00h01m |
| 001  | PID : | 0      |

Setting range 0 to 10

Initial value 0

When PID=0 is set, the previous execution step PID No. is looked up.

When PID=0 is set to the start step, the program is executed by PID No.1 at the start of the program.

**9-3 Pattern-related Settings****(1) Number of steps**

Set the number of steps to be used in the program pattern.

|     |              |    |
|-----|--------------|----|
| 2-1 |              | CH |
| PTN |              | 1  |
| 01  |              |    |
|     | Num. of STEP | 20 |
|     | Start STEP   | 1  |

Setting range 0 to 400

Initial value PTN1: 20

Other: 0

The maximum step number varies according to the numbers assigned to CH1 and CH2, or assigned to other pattern/step numbers.

For example, if 20 patterns are assigned to CH1, and 0 step number is assigned to the pattern No.2 to 20, the step numbers of pattern No.1 can be set up to 400 steps, which is the maximum numbers.

Set control action to a stopped (reset) state before performing this operation.



**(2) Start step**

Set the step at program start.

Setting range

0 to number of steps

Initial value

PTN1: 1

Other: 0

When "0" is set, that pattern becomes invalid.

**Note**

- ◆ This parameter can also be set before execution of program control in the basic screen. For details, see "15-2 Operations in Basic Screen."

**(3) Start SV**

Set the SV value at start of the program.

The start SV function is enabled only when the program is started from step 1.

Setting range

Within SV limiter setting range

Initial value

0.0

**Note**

- ◆ When the Start SV value exceeds the limit, the SV value is highlighted as shown left side.
- ◆ The highlighted SV value is replaced internally with the limiter value, and the SV value cut by the limiter is displayed on the SV display.
- ◆ For details, see "8-6 (2) SV limiter."

**(4) Pattern execution count**

Set the execution count of the program pattern. When a pattern execution count smaller than the current execution count is set during program execution, the program pattern ends after execution up to the end step. (If the pattern is linked, the program moves to the next pattern.)

|           |       |    |
|-----------|-------|----|
| 2-2       |       | CH |
| PTN       | 01    | 1  |
| Start SV: | 0.0°C |    |
| PTN Repts | 3     |    |

Setting range 1 to 9999

Initial value 1

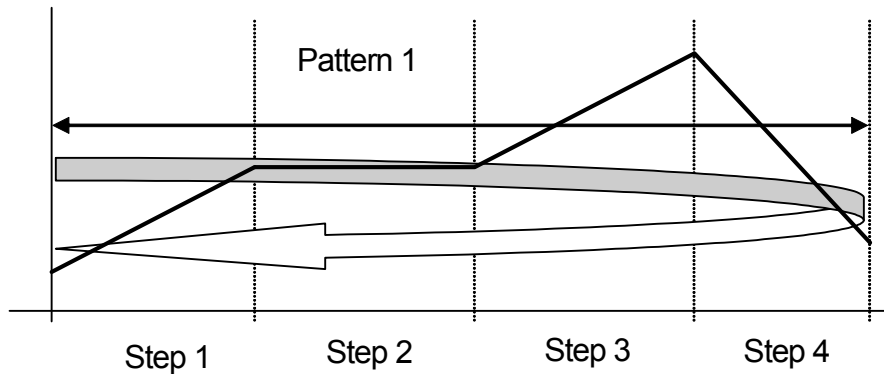

PTN 1 is executed three times.

**Ex) When the pattern execution count is set to "3" at PTN1 (from step 1 to 4)**

**(5) Start step No. of step loop**

Set the start step No. during step loop.

|     |            |    |
|-----|------------|----|
| 2-3 |            | CH |
| PTN | Loop Setup | 1  |
| 01  | Start      | 1  |
|     | End        | 1  |
|     | Reps       | 1  |

Setting range 1 to number of steps

Initial value 1

**(6) End step No. of step loop**

Set the end step No. during step loop.

|     |            |   |    |
|-----|------------|---|----|
| 2-3 |            |   |    |
| PTN | Loop Setup |   | CH |
| 01  | Start:     | 1 | 1  |
|     | End        | 1 |    |
|     | Reps       | 1 |    |

Setting range 1 to number of steps  
Initial value 1

**(7) Execution count of step loop**

Set the execution count of the step loop.

|     |            |   |    |
|-----|------------|---|----|
| 2-3 |            |   |    |
| PTN | Loop Setup |   | CH |
| 01  | Start:     | 2 | 1  |
|     | End        | 5 |    |
|     | Reps       | 3 |    |

Setting range 1 to 9999  
Initial value 1

**Ex) When execution count is set to "3" at start step No.2 and end step No.5**

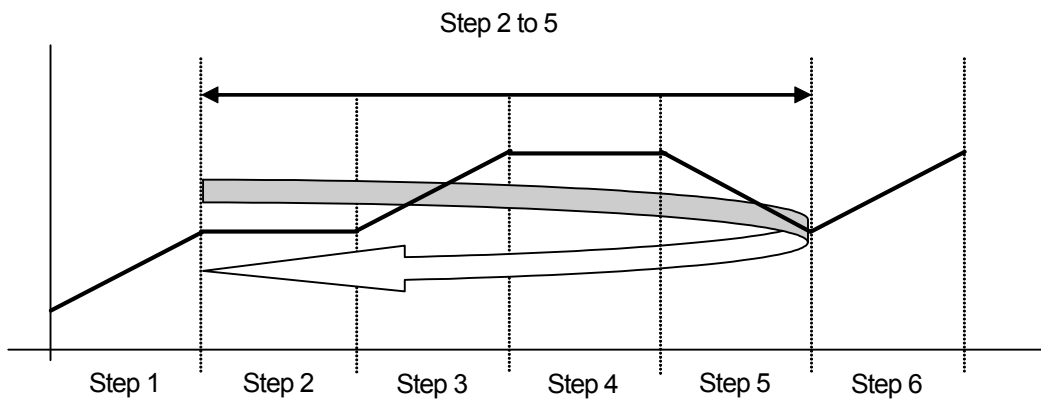

Step 2 to 5 is executed 3 times.

**(8) Guarantee soak zone**

Set the guarantee soak zone (hysteresis of guarantee soak function).  
 Set the setting value as a deviation with respect to the SV value of a flat step.

|     |           |        |    |
|-----|-----------|--------|----|
| 2-4 |           |        |    |
| PTN | GUArantee | Soak   | Ch |
| 01  | Zone      | OFF    | 1  |
|     | Time:     | 00h00m |    |
|     | PV Start: | OFF    |    |

Setting range      OFF,1 to 9999  
 Initial value      OFF

**What is the guarantee soak (GUA) function?**

During program control, when the SV value migrates from a ramp step to a flat step, the PV value sometimes can no longer track the SV value and the flat step time may become shorter on some control systems. This function is for avoiding this and assuring the time of the flat step.

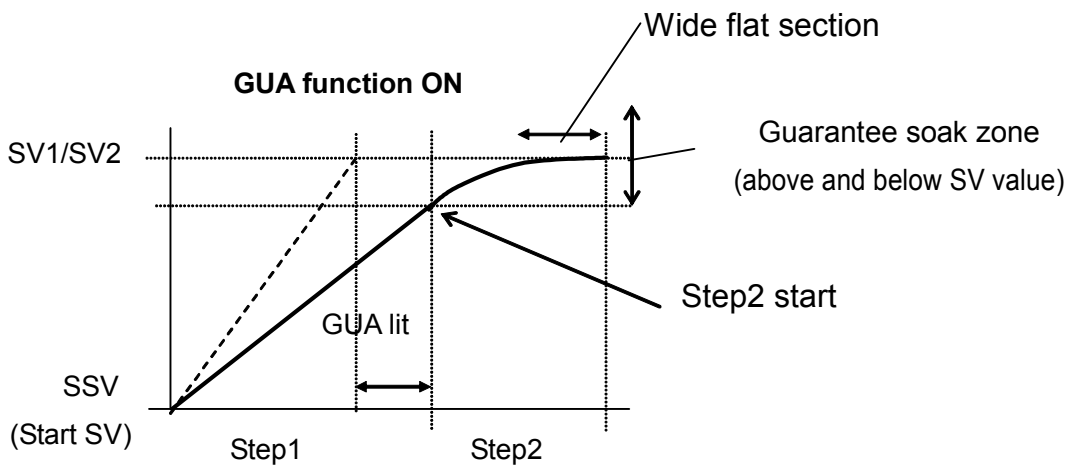
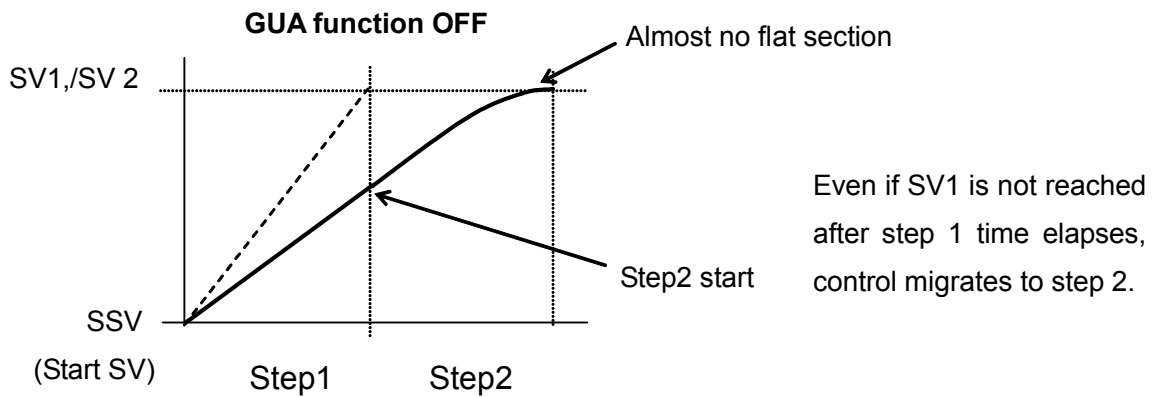

When the deviation between the step SV and PV of the flat step does not enter the guarantee soak zone when the ramp step switches to the flat step, the program does not move to the next step, and program execution stands by until this region is reached or the GUA time ends.

In the reset state, the GUA lamp  lights in the status monitor screen (0-3).

*Note*

- ◆ Even if step 1 is flat (SSV = SV1) when the RST mode changes to the PROG mode, guarantee soak is performed.
- ◆ Even in steps where the step time is set to "00:00", guarantee soak is performed if the guarantee soak conditions are satisfied.

### (9) Guarantee soak time

Set the guarantee soak time. Time measurement is performed at the same time that the ramp step time ends, and the program moves to the flat step regardless of whether the PV value is inside or outside the zone when the preset time is reached.

Note, however, that when "00:00" is set, GUA continues until PV reaches the zone.

|     |           |        |    |
|-----|-----------|--------|----|
| 2-4 |           |        |    |
| PTN | GUA       | Soak   | Ch |
| 01  | Zone:     | OFF    | 1  |
|     | Time:     | 00h00m |    |
|     | PV Start: | OFF    |    |

Setting range 00:00 to 99:59

Initial value 00:00

### (10) PV start

When the start step at program execution is ramp control, and the value of difference between start SV value and PV value is larger, dead time occurs. To omit this dead time, set the PV value for the purpose of starting as the start SV. When PV start is OFF, execution starts from the start SV at all times.

|     |           |        |    |
|-----|-----------|--------|----|
| 2-4 |           |        |    |
| PTN | GUA       | Soak   | Ch |
| 01  | Zone:     | OFF    | 1  |
|     | Time:     | 00h00m |    |
|     | PV Start: | OFF    |    |

Setting range ON/OFF

Initial value OFF

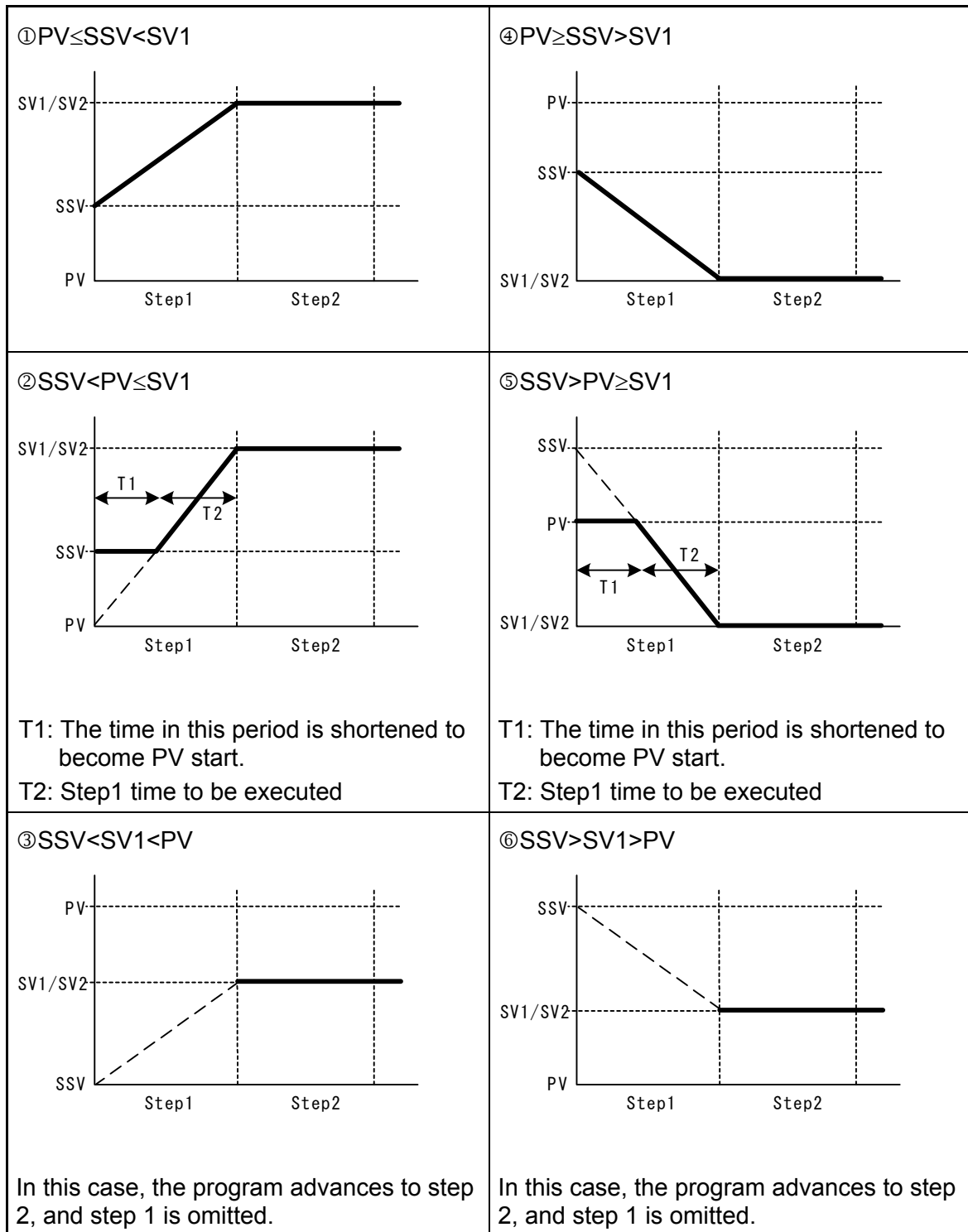

\*1 PV start is enabled only when the start step time is set to "00m01s" or more.

\*2 Cautions in ② and ⑤ action

Due to the relationship with the device's internal resolution, an accurate SSV (start SV value) might not be calculated when the PV start function is started up by conditions such as a large step SV rate-of-change.

## 9-4 Pattern Link-related Settings

### (1) Setting the pattern link execution count

Set the number of times that pattern link is executed.

|     |   |                |   |    |
|-----|---|----------------|---|----|
| 1-3 |   | PTN Link Repls | 0 | CH |
|     |   | Link Format    | 1 |    |
| 1st | 3 | 3rd            | 4 |    |
| 2nd | 1 | 4th            | 6 |    |

Setting range 0 to 9999

Initial value 0

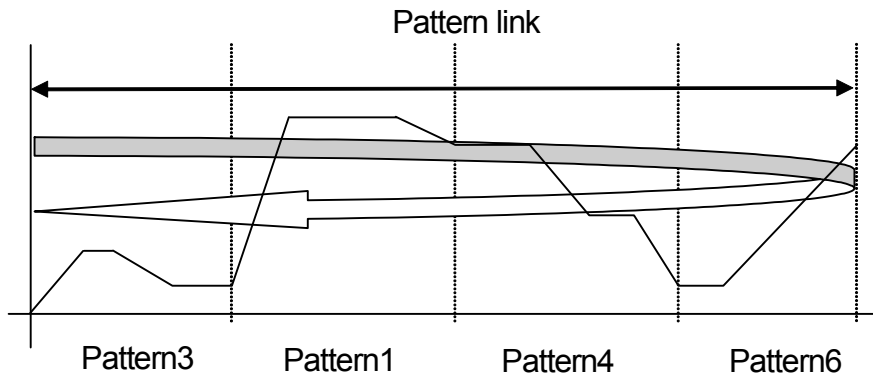

Note

- ◆ When "0" is set to the pattern link execution count, the link function is disabled.

### (2) Pattern link

This setting is for linking (connecting) and operating each pattern by a program.

Set the pattern No. to be linked in order from 1st pattern.

Up to 20 patterns can be linked from 1st to 20th.

The same pattern can also be set repeatedly.

|     |   |                |   |    |
|-----|---|----------------|---|----|
| 1-3 |   | PTN Link Repls | 1 | CH |
|     |   | Link Format    | 1 |    |
| 1st | 3 | 3rd            | 4 |    |
| 2nd | 1 | 4th            | 6 |    |

Setting range 0 to higher limit of assigned pattern

Initial value 0

Note

- ◆ When pattern 0 is set, the link to patterns set from then onwards becomes invalid.

## 9-5 Settings Before Program Operation

### (1) Auto-tuning point

To avoid hunting resulting from limit cycle with SV value in executing Auto Tuning, set a hypothetical SV value to carry out Auto Tuning at a point away from the actual SV value.

3-32  
 AT Point ▾ 0.0°C

Setting range 0, 1 to 10000 digit  
 Initial value 0

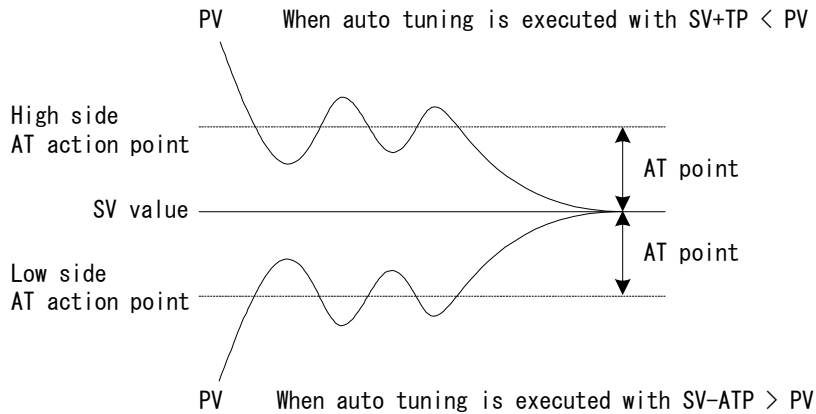

#### Note

- ◆ For ATP (AT point), set the AT action points above and below the SV as a deviation.
- ◆ When auto tuning is executed with PV outside of the preset AT points above and below, auto tuning is performed at an AT point between PV and SV.
- ◆ When auto tuning is executed with the PV value inside the At action points above and below, auto tuning is performed using the SV value.
- ◆ When ATP is set to "0", the SV value becomes the AT action points.
- ◆ When zone PID SV is selected, AT points become invalid.



**(2) Program EVENT/DO action points**

Set the action points of each of EVENT/DO in the Program mode.

This screen is not displayed when an action other than the six actions shown below is set to EVENT/DO.

In case an action point is assigned to another channel, this is not displayed on the screen.

2-5

| PTN | EV  | Set | Point   | Unit |
|-----|-----|-----|---------|------|
| 01  | EV1 | HD  | 2500.0  | °C   |
|     | EV2 | LD  | -2500.0 | °C   |
|     | EV3 | HD  | 2500.0  | °C   |

2-6

| PTN | DO  | Set | Point   | Unit |
|-----|-----|-----|---------|------|
| 01  | DO1 | HD  | 2500.0  | °C   |
|     | DO2 | LD  | -2500.0 | °C   |
|     | DO3 | HD  | 2500.0  | °C   |

2-7

| PTN | DO  | Set | Point   | Unit |
|-----|-----|-----|---------|------|
| 01  | DO4 | HD  | 2500.0  | °C   |
|     | DO5 | LD  | -2500.0 | °C   |

2-8

| PTN | DO  | Set | Point   | Unit |
|-----|-----|-----|---------|------|
| 01  | DO6 | HD  | 2500.0  | °C   |
|     | DO7 | LD  | -2500.0 | °C   |

2-9

| PTN | DO  | Set | Point   | Unit |
|-----|-----|-----|---------|------|
| 01  | DO8 | HD  | 2500.0  | °C   |
|     | DO9 | LD  | -2500.0 | °C   |

**Setting range**

|              |  |                              |
|--------------|--|------------------------------|
| HD (DEV Hi)  | Higher limit deviation                     | -25000 to 25000 <b>digit</b> |
| LD (DEV Low) | Lower limit deviation                      | -25000 to 25000 <b>digit</b> |
| OD (DEV Out) | Outside higher/lower limit deviation value | 0 to 25000 <b>digit</b>      |
| ID (DEV In)  | Inside higher/lower limit deviation value  | 0 to 25000 <b>digit</b>      |
| HA (PV Hi)   | PV higher limit absolute value             | Within measuring range       |
| LA (PV Low)  | PV lower limit absolute value              | Within measuring range       |

**Initial value**

|              |  |  |
|--------------|--|--|
| HD (DEV Hi)  | Higher limit deviation value               | 25000 <b>digit</b>                             |
| LD (DEV Low) | Lower limit deviation value                | -25000 <b>digit</b>                            |
| OD (DEV Out) | Outside higher/lower limit deviation value | 25000 <b>digit</b>                             |
| ID (DEV In)  | Inside higher/lower limit deviation value  | 25000 <b>digit</b>                             |
| HA (PV Hi)   | PV higher limit absolute value             | Within measuring range<br>(higher limit value) |
| LA (PV Low)  | PV lower limit absolute value              | Within measuring range<br>(lower limit value)  |

### (3) Time signal (TS)

Eight time signals are available for each pattern.

The following screen descriptions are for Time Signal 1 (TS1).

To use a time signal as an external output, TS1 to TS8 must be assigned to EV1 to EV3 and DO1 to DO9 in the EVENT/DO screen group.

#### ■ Time signal enabling conditions

Though invalid conditions can be assigned, they do not function.

1) The ON step No. must already be set (must not be OFF).

2) The ON step No.  $\leq$  the OFF step No.

Note, however, that the actual ON time  $\leq$  the actual OFF time.

- ◆ When the ON step No. = OFF step No.  
TS turns ON for 1 second when the actual ON time = actual OFF time
- ◆ When the ON step No. < OFF step No.  
TS turns ON for 1 second when the actual ON time = actual OFF time

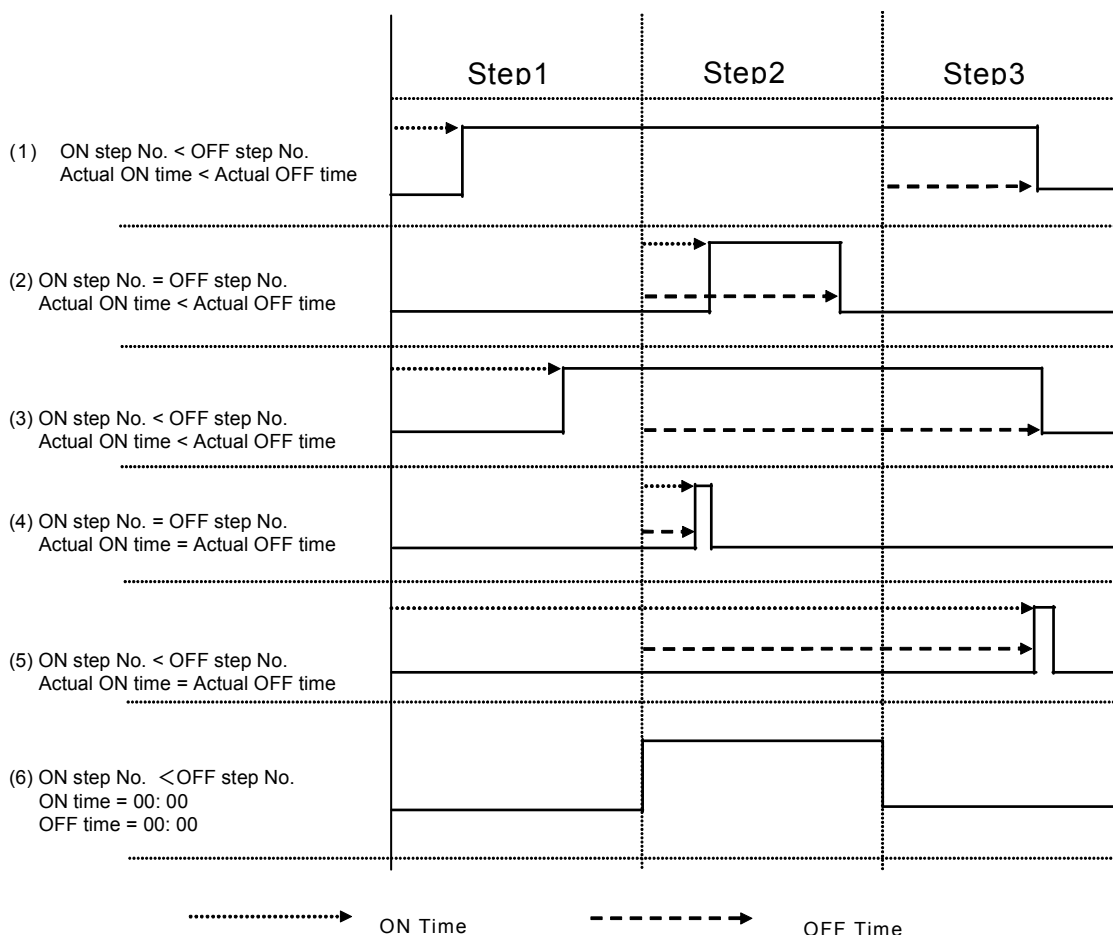

Actual ON time: the time until Time Signal will be ON after the program has started

Actual OFF time: the time until Time Signal will be OFF after the program has started

ON time: Time signal ON time

OFF time: Time signal OFF time

**< Other precautions relating to setting >**

- (1) The Time Signal (TS) tick is suspended during a Hold or Guarantee Soak.
- (2) If TS turns ON when the OFF step assigned is OFF with the ON step and ON time both enabled, TS stays ON until the end of the pattern.
- (3) When the OFF step or actual OFF time exceeds the end step time, TS output becomes OFF at the end of the pattern end step.  
Note, however, that it becomes ON when the ON time at the next pattern is 00:00.
- (4) When the ON time = step time, TS turns ON at the start of the next step.  
(including OFF time)
- (5) When TS values have been changed in a Hold state during program execution, the values will not be updated until after the hold state is released.

**① Time signal ON step No.**

Set the step No. at which Time signal 1 (TS1) turns ON.

2-10

|   |   |     |      |         |         |    |
|---|---|-----|------|---------|---------|----|
| P | T | N   | ON   | STEP    | OFF     | CH |
| 0 | 1 | ON  | Time | :00h00m | 1       |    |
|   |   | OFF | STEP | : OFF   |         |    |
| T | S | 1   | OFF  | Time    | :00h00m |    |

Setting range      OFF, 1 to number of steps  
Initial value      OFF

**② Time signal ON time**

Set the time from the start of the step at which Time signal 1 (TS1) turns ON up to when the signal actually turns ON.

2-10

|   |   |     |      |         |         |    |
|---|---|-----|------|---------|---------|----|
| P | T | N   | ON   | STEP    | OFF     | CH |
| 0 | 1 | ON  | Time | :00h00m | 1       |    |
|   |   | OFF | STEP | : OFF   |         |    |
| T | S | 1   | OFF  | Time    | :00h00m |    |

Setting range      00:00 to 99:59  
Initial value      00:00

**③ Time signal OFF step No.**

Set the step No. at which Time signal 1 (TS1) turns OFF.

2-10

|   |   |     |      |         |         |    |
|---|---|-----|------|---------|---------|----|
| P | T | N   | ON   | STEP    | OFF     | CH |
| 0 | 1 | ON  | Time | :00h00m | 1       |    |
|   |   | OFF | STEP | : OFF   |         |    |
| T | S | 1   | OFF  | Time    | :00h00m |    |

Setting range      OFF, 1 to number of steps  
Initial value      OFF

#### ④ Time signal OFF time

Set the time from the start of the step at which Time signal 1 (TS1) turns OFF up to when the signal actually turns OFF

```

2-10
PTN ON STEP: OFF CH
01 ON Time: 00h00m 1
OFF STEP: OFF
TS1 OFF Time: 00h00m
  
```

Setting range 00:00 to 99:59

Initial value 00:00

#### (4) Start pattern No.

Set the start pattern No. when executing a program.

This screen belongs not to PROGRAM (program screen group) but to CTRL EXEC (execution screen group).

```

1-2
HLD: OFF CH
ADV: OFF 1
Start PTN 1
  
```

Setting range 1 to higher limit of assigned pattern

Initial value 1

#### Note

- ◆ This pattern can also be set before program control execution in the basic screen. For details, see "15-2 Operations in Basic Screen."

## 10 FIX SETTINGS

### 10-1 Switching the FIX Mode

The FP23 can be set to the FIX (fixed value control) mode.

Note that movement to the FIX mode when the Program mode is switched to the FIX mode varies according to the FIX MOVE setting.

For details, see "10-4 FIX MOVE".

```

1-6
FIX MODE: OFF CH 1
FIX SV : 0.0°C
FIX PID : 1
FIX MOVE: EXE
  
```

Setting range ON, OFF

Initial value OFF

ON FIX (fixed value control) mode

OFF Program mode

*Note*

- ◆ Switching between the Program mode and the FIX mode is also possible in the basic screen.

### 10-2 FIX SV Value

Set the SV value during fixed value control (FIX mode: ON).

```

1-6
FIX MODE: OFF CH 1
FIX SV : 0.0°C
FIX PID : 1
FIX MOVE: EXE
  
```

Setting range Within SV limiter setting range

Initial value 0 digit

*Note*

```

1-6
FIX MODE: OFF CH 1
FIX SV : 400.0°C
FIX PID : 1
FIX MOVE: EXE
  
```

- ◆ When the FIX SV value exceeds the limit, the SV value is highlighted as left side.
- ◆ The highlighted SV value is replaced internally with the limiter value, and the SV value cut by the limiter is displayed on the SV display.
- ◆ For details, see "8-6 (2) SV limiter."

### 10-3 FIX PID No.

Set the PID No. during fixed value control (FIX mode: ON).  
The PID No. cannot be set when Zone PID is enabled. ("Zone" is displayed.)

```

1-6
FIX MODE: OFF          CH
FIX SV : 0.0°C        1
FIX PID: 1
FIX MOVE: EXE

```

Setting range 1 to 10

Initial value 1

### 10-4 FIX MOVE

Make detailed settings for when the FP23 enters FIX mode.

```

1-6
FIX MODE: OFF          CH
FIX SV : 0.0°C        1
FIX PID: 1
FIX MOVE: EXE

```

Setting range EXE, EXE/STBY, EXE/TRCK

Initial value EXE

- EXE Switch to RUN state when transferring to FIX mode.
- EXE/STBY Current (RUN/RST) state is maintained when transferring to FIX mode.
- EXE/TRCK In case of RST state, switch to RUN state when transferring to FIX mode.  
In case of RUN state, track the SV and PID No. that have been used just before, and switch to RUN state.

| FIX MOVE | Before Move → After Move | Remarks  |
|----------|--------------------------|--|
| EXE      | PRG RST → FIX RUN        | Enters the RUN mode.                           |
|          | PRG RUN → FIX RUN        | Stays in the RUN mode.                         |
| EXE/STBY | PRG RST → FIX RST        | Stays in the RST mode.                         |
|          | PRG RUN → FIX RUN        | Stays in the RUN mode.                         |
| EXE/TRCK | PRG RST → FIX RUN        | Enters the RUN mode.                           |
|          | PRG RUN → FIX RUN        | Executing SV value and PID values are tracked. |

**Note**

- ◆ When the FP23 moves from FIX mode to the Program mode, the FP23 maintains its current state (RUN or Reset).

## 10-5 FIX EVENT/DO Action Points

Set each of the EVENT/DO action points in the FIX mode.

This screen is not displayed when a mode other than the six actions shown below is set to EVENT/DO. In case an action point is assigned to another channel, this is not displayed on the screen.

1-7

| FIX | EV | Set Point | CH |
|-----|----|-----------|----|
| EV1 | HD | 2500.0    | 1  |
| EV2 | LD | -2500.0   |    |
| EV3 | HD | 2500.0    |    |

1-8

| FIX | DO | Set Point | CH |
|-----|----|-----------|----|
| D01 | HD | 2500.0    | 1  |
| D02 | LD | -2500.0   |    |
| D03 | HD | 2500.0    |    |

1-9

| FIX | DO | Set Point | CH |
|-----|----|-----------|----|
| D04 | HD | 2500.0    | 1  |
| D05 | HD | 2500.0    |    |

1-10

| FIX | DO | Set Point | CH |
|-----|----|-----------|----|
| D06 | HD | 2500.0    | 1  |
| D07 | HD | 2500.0    |    |

1-11

| FIX | DO | Set Point | CH |
|-----|----|-----------|----|
| D08 | HD | 2500.0    | 1  |
| D09 | HD | 2500.0    |    |

### Setting range

|              |  |                        |
|--------------|--|------------------------|
| HD (DEV Hi)  | Higher limit deviation                     | -25000 to 25000 digit  |
| LD (DEV Low) | Lower limit deviation                      | -25000 to 25000 digit  |
| OD (DEV Out) | Outside higher/lower limit deviation value | 0 to 25000 digit       |
| ID (DEV In)  | Inside higher/lower limit deviation value  | 0 to 25000 digit       |
| HA (PV Hi)   | PV higher limit absolute value             | Within measuring range |
| LA (PV Low)  | PV lower limit absolute value              | Within measuring range |

### Initial value

|              |  |  |
|--------------|--|--|
| HD (DEV Hi)  | Higher limit deviation value               | 25000 digit                                    |
| LD (DEV Low) | Lower limit deviation value                | -25000 digit                                   |
| OD (DEV Out) | Outside higher/lower limit deviation value | 25000 digit                                    |
| ID (DEV In)  | Inside higher/lower limit deviation value  | 25000 digit                                    |
| HA (PV Hi)   | PV higher limit absolute value             | Within measuring range<br>(higher limit value) |
| LA (PV Low)  | PV lower limit absolute value              | Within measuring range<br>(lower limit value)  |

This page left intentionally blank.



## 11 PID SETTING

### 11-1 Proportional Band (P)

"Proportional band" refers to the range in which control output changes in proportion to the difference (deviation) between the measured value (PV) and the set value (SV). Here, set the percentage (%) that control output is made to change with respect to the measuring range.

When a wide proportional band is set, the change in the control output with respect to deviation decreases, and the offset (constant deviation) increases.

When a narrow proportional band is set, the change in the control output increases, and the offset decreases.

If too narrow a proportional band is set, hunting (vibration) occurs, and action becomes similar to that of ON-OFF control.

When P=OFF is set, control becomes ON-OFF control, and auto tuning cannot be executed.

3-1

|            |      |     |      |
|------------|------|-----|------|
| PID01-OUT1 |      |     |      |
| P          | 3.0% | MR: | 0.0% |
| I          | 120s | SF: | 0.40 |
| D          | 30s  |     |      |

|               |                     |
|---------------|---------------------|
| Setting range | OFF, 0.1 to 999.9 % |
| Initial value | 3.0 %               |

### 11-2 Integral Time (I)

Integral action is a function for correcting the offset (constant deviation) that occurs due to proportional action.

When a long integral time is set, offset correction action is weak, and it takes a long time to correct the offset. The shorter an integral time is set, the stronger the correction action becomes. However, if too short an integral time is set, hunting (vibration) occurs, and action becomes similar to that of ON-OFF control.

3-1

|            |      |     |      |
|------------|------|-----|------|
| PID01-OUT1 |      |     |      |
| P          | 3.0% | MR: | 0.0% |
| I          | 120s | SF: | 0.40 |
| D          | 30s  |     |      |

|               |                  |
|---------------|------------------|
| Setting range | OFF, 1 to 6000 s |
| Initial value | 120 s            |

When auto tuning is executed with I=OFF, the manual reset (MR) value is computed and automatically set.

For details on automatic setting of MR, see "11-4 Manual Reset (MR)."

### 11-3 Derivative Time (D)

Derivative action functions in two ways. It forecasts changes in the control output to reduce influence caused by external disturbance, and suppresses overshoot caused by integral action to improve control stability.

The shorter a derivative time is set, the weaker derivative action becomes. Alternatively, the longer a derivative time is set, the stronger derivative action becomes. However, if too long a derivative time is set, hunting (vibration) occurs, and action becomes similar to that of ON-OFF control.

3-1

|            |          |
|------------|----------|
| PID01-OUT1 |          |
| P: 3.0%    | MR: 0.0% |
| I: 120s    | SF: 0.40 |
| D: 30s     |          |

Setting range      OFF, 1 to 3600 s  
Initial value      30 s

When auto tuning is executed with D=OFF, computation is performed only by P1 value (proportional and integral).

### 11-4 Manual Reset (MR)

This function manually corrects offset that occurs when control action is performed by P or P+D (I=0) control.

When a + side MR value is set, the control result shifts to the + side, and when a – MR value is set, the control action shifts to the – side. The amount of shift is proportional to the size of the numerical value that is set.

3-1

|            |          |
|------------|----------|
| PID01-OUT1 |          |
| P: 3.0%    | MR: 0.0% |
| I: OFF     | SF: 0.40 |
| D: 30s     |          |

Setting range      -50.0 to 50.0 %  
Initial value      0.0 %  
50.0 % (in 1-loop/2-output specification)

#### ■ Automatic setting of MR

When auto tuning is executed with I=OFF, the manual reset (MR) value is computed and automatically set.

During PID control, MR is used as the target load ratio in PID initial operation.

For this reason, to reduce overshoot when the power is turned ON or when RST is switched to RUN, set a small MR value to lower this target load ratio.

When auto tuning is performed by PID control on the FP23, the load ratio is calculated so that offset is decreased even if there is no I action, and a value corresponding to the manual reset is automatically set.

This function enables control results superior to those enabled by regular PID control to be obtained.

### 11-5 Action Hysteresis (DF)

This item sets the hysteresis (DF) in ON-OFF control action when P is set to OFF. When a narrow hysteresis is set, chattering is more likely to occur on the output. When a wide hysteresis is set, chattering, etc. can be avoided and stable control action can be obtained.

3-1

|            |        |
|------------|--------|
| PID01-OUT1 |        |
| P:         | OFF    |
| DF         | 2.0 °C |

Setting range 1 to 9999 digit  
Initial value 20 digit

### 11-6 Dead Band (DB)

This setting is for only the 1-loop 2-output specification. Set the action range of output 2 (OUT2) taking the characteristics of the control target and energy savings into consideration.

|            |               |
|------------|---------------|
| PID01-OUT2 |               |
| P:         | 3.0% DB 0.0°C |
| I:         | OFF SF: 0.40  |
| D:         | 30s           |

Setting range -19999 to 20000 digit  
Initial value 0 digit

The patterns in the following figures show the relationship between output action and dead band.

RA: Reverse Action, DA: Direct Action

#### ■ Control output 1:RA, Control output 2: DA (RA+DA)

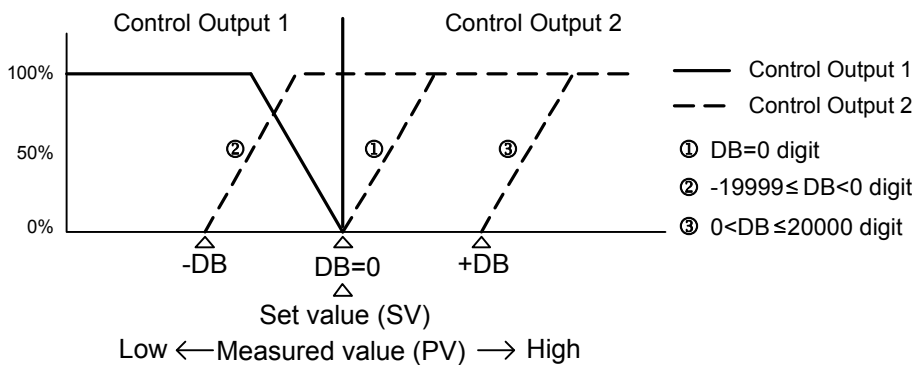

■ Control output 1:RA, Control output 2: RA (RA+RA)

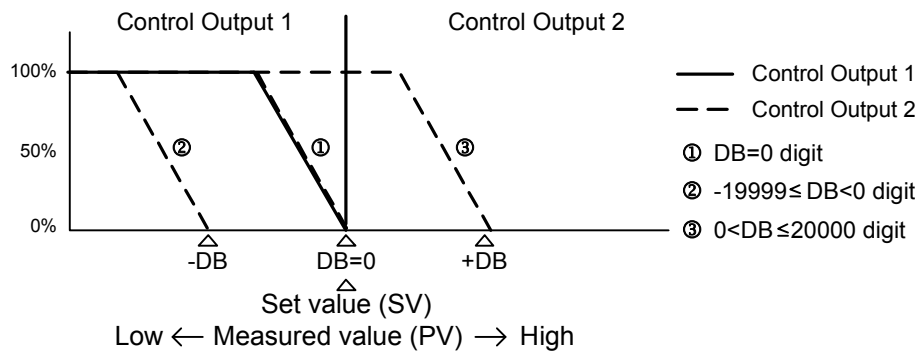

■ Control output 1:DA, Control output 2: RA (DA+RA)

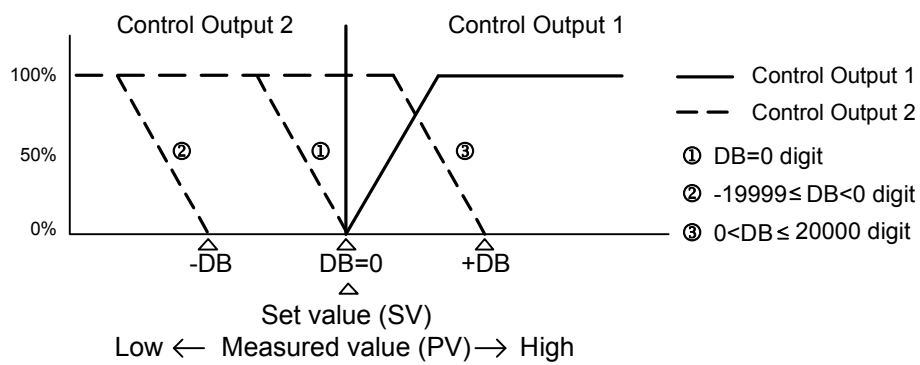

■ Control output 1:DA, Control output 2: DA (DA+DA)

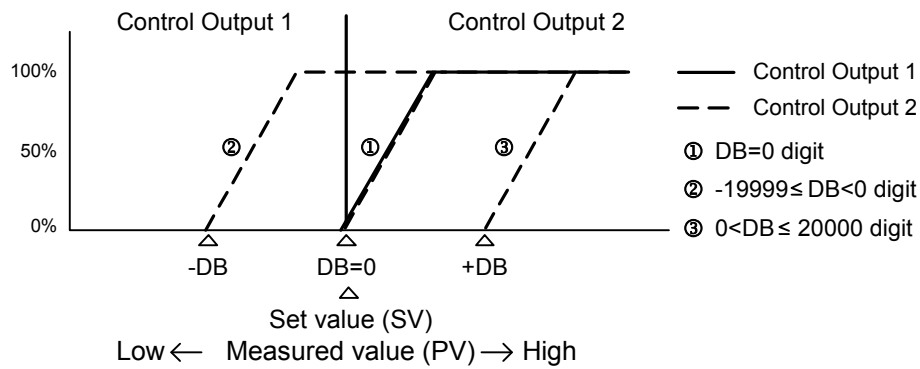

### 11-7 Set Value Function (SF)

This function determines the strength for preventing overshooting that occurs during Expert PID control.

Set Value Function is valid only when integral action (PI or PID) is set.

3-1

|            |   |
|------------|---|
| PID01-OUT1 |   |
| P: 3.0%    | MR: 0.0%                                    |
| I: OFF     | SF <input checked="" type="checkbox"/> 0.40 |
| D: 30s     |   |

Setting range      0.00 to 1.00  
Initial value      0.40

- SF = 0.00      Regular PID control is carried out, and the overshoot correction function is disabled.
- SF → Small      Overshoot correction is small.
- SF → Large      Overshoot correction is large.

■ **Reference: About PID action according to set value function (SF)**

During a ramp step, PID and PD action can be switched automatically by the SF value. Overshooting in flat steps can be reduced by controlling a ramp step by PD section.

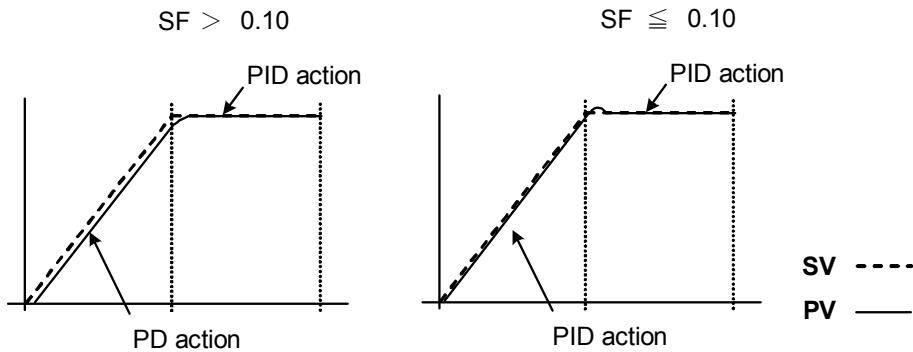

## 11-8 Output Limit Value (OUT1L to OUT2H)

This is the screen for setting the lower limit value and higher limit value of the control output corresponding to the PID No.

Though regular control is performed using the initial values as they are, these lower limit and higher limit values are used for control that requires higher accuracy.

In a heating control specification, set a lower limit value when the return value is slow arriving due to overshoot at the upper side. For control targets whose temperature immediately drops when the temperature rise is slow and output is lowered.

When the 2-output specification is selected, OUT1 is displayed on the upper row, and OUT2 is displayed on the lower row.

3-2

|       |        |        |
|-------|--------|--------|
| PID01 | OUT1L  | 0.0%   |
|       | OUT1H: | 100.0% |
|       | OUT2L: | 0.0%   |
|       | OUT2H: | 100.0% |

Setting range

Lower limit value 0.0 to 99.9 %

Higher limit value 0.1 to 100.0 %

(Lower limit value < Higher limit value)

Initial value

Lower limit value 0.0 %

Higher limit value 100.0 %

*Note*

- ◆ The output limiter is invalid during contact output or SSR drive voltage output when P=OFF is set and ON-OFF control is selected.

### 11-9 Zone PID

This function sets two or more zones in a measuring range and switches different PID values in each zone for use.

When this function is used, the optimum PID value can be set to each temperature range (zone) so that satisfactory controllability is obtained in a wide temperature range.

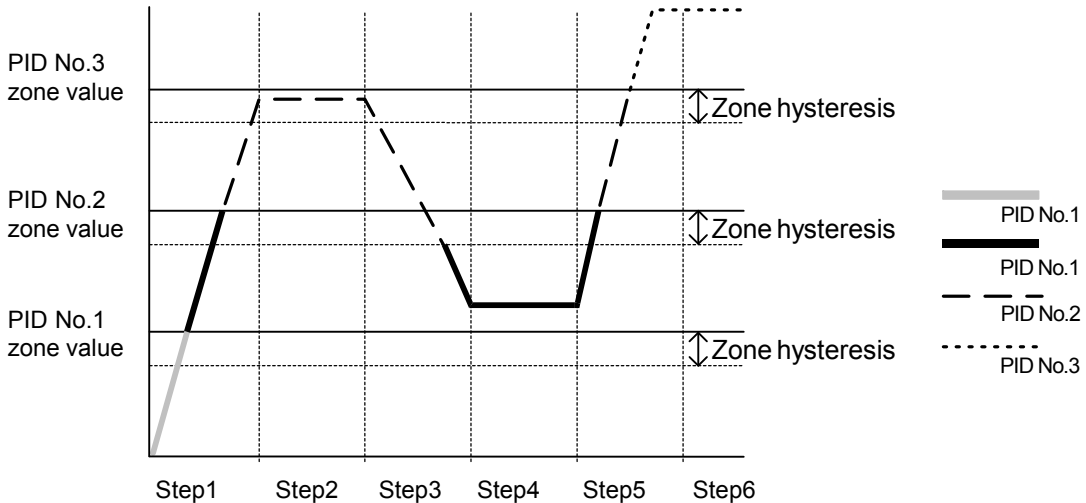

**Note**

- ◆ When the same zone value is set to multiple PID Nos., the PID No. having the smallest No. is executed.
- ◆ Even if the zone value or zone hysteresis is changed with the SV value inside zone hysteresis, the execution PID No. will not be changed until the SV No. leaves zone hysteresis.

#### (1) Selecting Zone PID

Select whether or not to use Zone PID.

When this function is used, further select whether to set the zone by SV or by PV. Zone PID2 is displayed in 2-loop specification.

3-31 Other than 2-loop

|           |                                     |     |
|-----------|-------------------------------------|-----|
| Zone PID1 | <input checked="" type="checkbox"/> | OFF |
| HYS1:     |                                     | 2.0 |

2-loop

|           |                                     |     |
|-----------|-------------------------------------|-----|
| Zone PID1 | <input checked="" type="checkbox"/> | OFF |
| HYS1:     |                                     | 2.0 |
| PID2:     |                                     | OFF |
| HYS2:     |                                     | 2.0 |

OFF Zone PID function is disabled.

SV Zone PID function of SV is used.

PV Zone PID function of PV is used.

**(2) Zone hysteresis**

The hysteresis can be set with respect to the zone set value.  
 This hysteresis is valid for all zone set values.  
 Zone HYS2 is displayed in 2-loop specification.

3-31 Other than 2-loop

|      |       |     |
|------|-------|-----|
| Zone | PID1: | OFF |
|      | HYS1  | 2.0 |

2-loop

|      |       |     |
|------|-------|-----|
| Zone | PID1: | OFF |
|      | HYS1  | 2.0 |
|      | PID2: | SV  |
|      | HYS2: | 2.0 |

Setting range 0 to 1000 digit  
 Initial value 20 digit

**(3) PID zone value**

Set the zone value (temperature range) to be used by the Zone PID function for each PID No.

3-1

|            |          |
|------------|----------|
| PID01-OUT1 |          |
| P: 3.0%    | MR: 0.0% |
| I: 120s    | SF: 0.40 |
| D: 30s     | ZN 0.0°C |

Setting range Within measuring range  
 Initial value 0 digit

**Note**

- ◆ When the same zone value is set to two or more PID Nos., the PID having the smallest No. is executed.
- ◆ To use the Zone PID function, zone setting and zone hysteresis must be set.



# 12 EVENT & DO SETTING

## 12-1 Monitor Screens

### (1) DO monitor

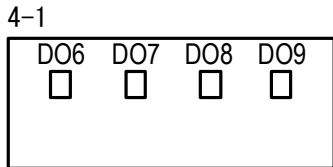

When DOx (x: 6 to 9) turns ON,  is highlighted as . DO6 to DO9 are optional, then they are not displayed when they are not installed.

### (2) Logic monitor

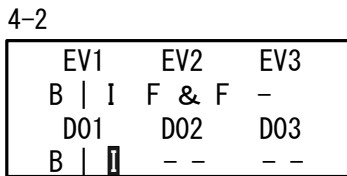

This screen is displayed when LOGIC is assigned to one or more EVENT/DOS.

LOGIC                    |: OR    &: AND    ^: XOR  
 Input                    B: Buffer    F: Flip flop    I: Inverter

The cursor position is highlighted.  
 In the screen as above, Buffer and Inverter are assigned to DO1 to make the device perform OR operation on both inputs.

## 12-2 Channel Setting

Set channel(s) corresponding to event action.  
 This may be set only in the 2-input 2-loop specification.

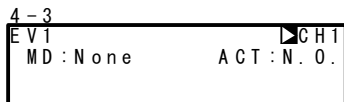

Setting range            CH1, CH2  
 Initial value            CH1

## 12-3 EVENT/DO Action

Note that if you have changed this setting, action set points (SP) and hysteresis (DF) parameters are initialized.

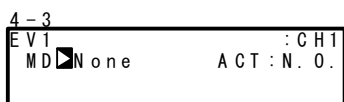

Setting range            See "List of EVENT/DO Types".  
 Initial value            EV1: DEV Hi  
                               EV2: DEV Low  
                               EV3: RUN  
                               DO1 to 9: None

■ List of EVENT/DO Types

| No. | Mode    | Action                               | No.      | Mode       | Action                             |
|-----|---------|--------------------------------------|----------|------------|------------------------------------|
| 1   | None    | No action                            | 12       | LOGIC      | Logic operation (AND/OR/XOR)       |
| 2   | DEV Hi  | Higher limit deviation value         |          | LOGIC      | Logic operation (Timer/Count)      |
| 3   | DEV Low | Lower limit deviation value          |          | Direct     | Direct output                      |
| 4   | DEV Out | Outside higher/lower limit deviation | 13       | RUN        | Program/FIX execution              |
| 5   | DEV In  | Inside higher/lower limit deviation  | 14       | HLD        | Hold                               |
| 6   | PV Hi   | PV higher limit absolute value       | 15       | GUA        | Guarantee soak                     |
| 7   | PV Low  | PV lower limit absolute value        | 16       | STEP       | Step signal                        |
| 8   | SO      | Scale over                           | 17       | PRG.END    | End signal                         |
| 9   | FIX     | FIX mode                             | 18 to 25 | TS1 to TS8 | Time signal 1 to 8                 |
| 10  | AT      | Auto tuning execution in progress    | 26       | HBA        | Heater break alarm output (option) |
| 11  | MAN     | Manual operation in progress         | 27       | HLA        | Heater loop alarm output (option)  |

\*1 LOGIC operations (AND/OR/XOR) can be assigned only to EV1 to EV3, and DO1 to DO3.

\*2 LOGIC operations (Timer/Count) can be assigned only to DO4 and DO5.

\*3 Only DO6 to DO9 can be assigned to Direct. The Direct function can be used when the communication option is added on.

■ EVENT/DO Action Diagrams

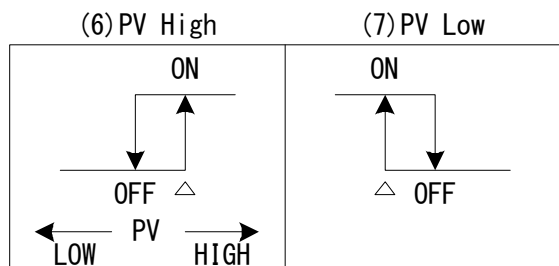
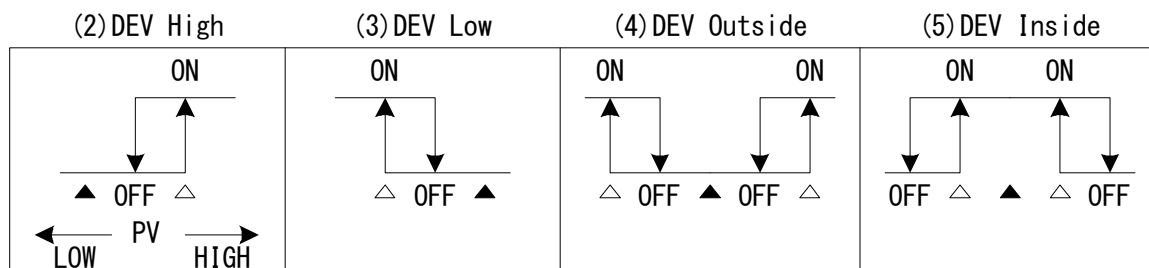

△ Action set point      ▲ Set value

\* "ON" "OFF" indicates the action states.  
EVENT/DO output conforms to the setting (OPEN/CLOSE) of output characteristics.

■ **EVENT/DO Action in RST State**

When the actions in the table below are assigned to EVENT/DO, EVENT/DO do not function in a Reset (RST) state.

| Mode    | Action                               | Mode   | Action                              |
|---------|--------------------------------------|--------|-------------------------------------|
| DEV Hi  | Higher limit deviation value         | DEV In | Inside higher/lower limit deviation |
| DEV Low | Lower limit deviation value          | PV Hi  | PV higher limit absolute value      |
| DEV Out | Outside higher/lower limit deviation | PV Low | PV lower limit absolute value       |

(1) **Output characteristics**

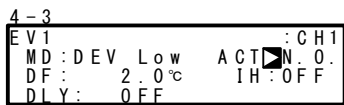

Setting range      N.O., N.C.  
Initial value        N.O.

- N.O.(normally open) When EVENT/DO turns ON, contacts are closed or output transistor turns ON.
- N.C.(normally closed) When EVENT/DO turns ON, contacts are opened or output transistor turns OFF.

(2) **Hysteresis**

Set the hysteresis between ON action and OFF action. Setting hysteresis can avoid chattering, etc., and obtain stable action. This item is displayed when Modes (2) to (7) are selected in EVENT/DO action.

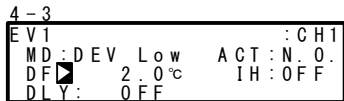

Setting range      1 to 9999 digit  
Initial value        20 digit

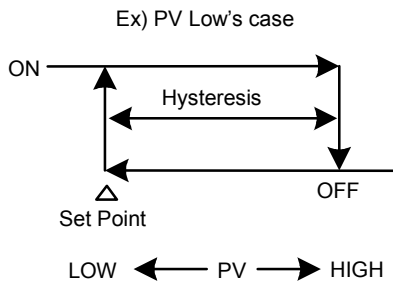

**(3) Delay time**

This function is for turning EVENT/DO ON after the preset time has elapsed after an EVENT/DO source has been generated.

This item is displayed when Modes (2) to (7) are selected in the EVENT/DO action.

```

4-3
EVT : CH1
MD : DEV Low  ACT : N.O.
DF : 2.0°C  IH : OFF
DLY : OFF

```

Setting range OFF, 1 to 9999 s

Initial value OFF

**Note**

- ◆ EVENT/DO is not output when the source of the signal output disappears during the delay time. When the source is generated again, counting of the time is performed from the beginning.
- ◆ When the delay time is set to OFF, EVENT/DO is output at the same time that the source of EVENT/DO is generated.
- ◆ When an EVENT/DO source is generated within the delay time operation, the delay time can be changed. Note, however, that the delay time is the time not from when measurement is performed from the newly set time but from the time that was measured from when the output source was generated.

**(4) Inhibit Action**

This function is for turning EVENT/DO ON when the PV value leaves the EVENT/DO action range and enters the range again without outputting EVENT/DO even if the PV value is in the action range at power ON.

Select this item taking Inhibit Action and event action at scale over into consideration.

This item is displayed when Modes (2) to (7) are selected in the EVENT/DO action.

```

4-3
EVT : CH1
MD : DEV Low  ACT : N.O.
DF : 2.0°C  IH : OFF
DLY : OFF

```

Setting range OFF, 1, 2, 3

Initial value OFF

OFF Inhibit action is not performed.

- 1 Inhibit action is executed at power ON and when the control state changes from RST to RUN.
- 2 Inhibit action is executed at power ON, when the control state changes from RST to RUN, and when the state of SV has changed.
- 3 Inhibit action is not performed (action OFF at scale over input error).

**Note**

- ◆ When IH is set to OFF, 1 or 2, EVENT/DO action turns ON when a scale over error occurs on the EVENT/DO set side.
- ◆ When IH is set to 3, EVENT/DO action turns OFF when a scale over error occurs on the EVENT/DO set side.
- ◆ To output an alarm when a scale over error occurs with IH set to 3, assign scale over (SO) to other EVENT/DO.

## 12-4 Event Logic Operations

Logic operations can be assigned to EV1 to EV3, and DO1 to DO3.

This function performs logic operations on inputs from two DIs or Time signals, and outputs the result to EVENT/DO. DI signal can also be output by communication. Simple sequences can be performed by using timer/count functions.

### ■ Event logic operation block diagram

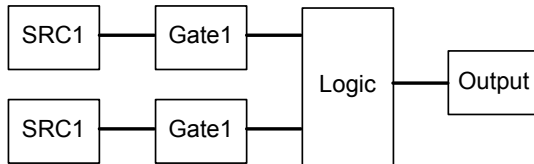

### ■ Configuration example

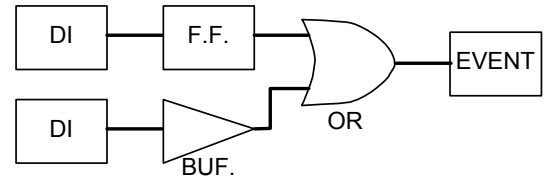

The screens below are for when [LOGIC] has been assigned to EV1.

### (1) Logic operation mode (Log MD)

|            |            |
|------------|------------|
| 4-3        |            |
| EV1 Log MD | AND        |
| MD: LOGIC  | ACT: N. O. |
| SRC1: None | Gate1: BUF |
| SRC2: None | Gate2: BUF |

Setting range

AND, OR, XOR

Initial value

AND

|     |                             |   |
|-----|-----------------------------|---|
| AND | Logical product of 2 inputs | EVENT/DO turn ON when both of the two inputs turn ON.                         |
| OR  | Logical sum of 2 inputs     | EVENT/DO turn ON when either of the two inputs turns ON.                      |
| XOR | Exclusive OR of 2 inputs    | EVENT/DO turn ON when one of the two inputs turns ON and the other turns OFF. |

### (2) Assigning logic operation input (SRC1, SRC2)

Assign the DI No. or time signal No. to two inputs (SRC1 & SRC2) for logic operation.

|            |            |
|------------|------------|
| 4-3        |            |
| EV1 Log MD | AND        |
| MD: LOGIC  | ACT: N. O. |
| SRC1: None | Gate1: BUF |
| SRC2: None | Gate2: BUF |

Setting range

None, TS1 to TS8, TS1-C2 to TS8-C2, DI1 to DI10

Initial value

None (no assignment)

#### Note

- ◆ When another function is assigned to DI, the function also starts to operate when that DI signal is input.
- ◆ When the assignment to DI is set to None, the function does not operate.

**(3) Logic operation input logic (Gate1, Gate2)**

Set the logic of the two inputs for logic operation.

```

4-3
EVT Log MD: AND
MD: LOGIC   ACT: N. O.
SRC1: None  Gate1: BUF
SRC2: None  Gate2: BUF
  
```

Setting range      BUF, INV, FF  
Initial value      BUF

BUF (buffer)      The input signal is treated as it is.  
INV (inverter)    The input signal is inverted, then treated as the logic signal.  
FF (flip-flop)    The logic signal toggles each time the input signal turns from OFF to ON.

**Note**

- ◆ When the logic operation input is a time signal (TS1 to TS8), FF (flip-flop) cannot be set.

**12-5 Timers/Counters**

Timers and counters can be assigned to DO4 and DO5.

With this function, DI or TS is taken as input and EVENT/DO is taken as output, and EVENT/DO can be output after the preset time has elapsed after generation of an input, or when the input of the preset count is reached.

The timers and counters operate regardless of the control action of this device, and output a one-shot pulse of one second.

The screens below are for when [LOGIC] has been assigned to DO4 and DO5.

**(1) Timer time**

The time can be set within the range 1 to 5000 seconds only when the mode (Log MD) is set to timer.

```

4-9
DO4 Time OFF
MD: LOGIC   ACT: N. O.
SRC: None
Log MD: Timer
  
```

Setting range      OFF, 1 to 5000 s  
Initial value      OFF

**(2) Counter**

The count can be set within the range 1 to 5000 only when the mode (Log MD) is set to counter.

The pulse width of DI must be 100ms or more.

```

4-9
DO4 Count OFF
MD: LOGIC   ACT: N. O.
SRC: None
Log MD: Counter
  
```

Setting range      OFF, 1 to 5000  
Initial value      OFF

**(3) Assigning input (SRC)**

Assign the DI No. or TS No.

|               |            |
|---------------|------------|
| 4-9           |            |
| D04           | Time: OFF  |
| MD: LOGIC     | ACT: N. O. |
| SRC: None     |            |
| Log MD: Timer |            |

Setting range

None, TS1 to TS8, TS1-C2 to TS8-C2, DI1 to DI10

Initial value

None (no assignment)

**Note**

- ◆ When another function is assigned to DI, the function also starts to operate when that DI signal is input.
- ◆ When the assignment to DI is set to None, the function does not operate even if the DI signal is input.

**(4) Mode (Log MD)**

Select and set timer or counter.

|               |            |
|---------------|------------|
| 4-9           |            |
| D04           | Time: OFF  |
| MD: LOGIC     | ACT: N. O. |
| SRC: None     |            |
| Log MD: Timer |            |

Setting range

Timer, Counter

Initial value

Timer

Timer DO turns ON after DI is input and a preset time elapses.

Counter DO turns ON when DI input count reaches the preset value.

This page left intentionally blank.



# 13 OPTION SETTINGS (DI, AO, HB, COM)

## 13-1 DI

DI is digital input for external control based upon an externally input non-voltage contact signal or an open collector signal.

Actions can be selected, and assigned to DI2 to DI10.

Note, however, that DI1 is fixed to RUN/RST (CH1).

### (1) DI monitor screen

is highlighted as  when a signal is input to DI regardless of whether or not DI is assigned.

DI5 to DI10 are optional, and are not displayed when they are not available.

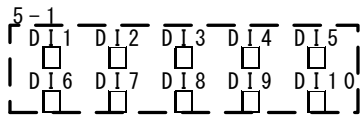

### (2) Assignment of a Channel to DI

This is the assignment to DI.

In case of 2-loop specification, assignment may be done to either CH1 or CH2, or to both CH1 and CH2 at the same time.

|     |         |   |
|-----|---------|---|
| 5-2 |         |   |
| DI1 | RUN/RST | <input checked="" type="checkbox"/> CH1 |
| DI2 | None    | : CH1                                   |
| DI3 | None    | : CH1                                   |
| DI4 | None    | : CH1                                   |

Setting range CH1, CH2, CH1+2  
Initial value CH1

### (3) List of DI Types.

One of the parameters (Modes) described in the Table “List of DI Types” can be assigned to DI.

|     |         |   |
|-----|---------|---|
| 5-2 |         |   |
| DI1 | RUN/RST | <input checked="" type="checkbox"/> CH1 |
| DI2 | None    | : CH1                                   |
| DI3 | None    | : CH1                                   |
| DI4 | None    | : CH1                                   |

|     |      |   |
|-----|------|---|
| 5-3 |      |   |
| DI5 | None | <input checked="" type="checkbox"/> CH1 |
| DI6 | None | : CH1                                   |
| DI7 | None | : CH1                                   |
| DI8 | None | : CH1                                   |

|      |      |   |
|------|------|---|
| 5-4  |      |   |
| DI9  | None | <input checked="" type="checkbox"/> CH1 |
| DI10 | None | : CH1                                   |

LG is displayed for the DI to be used by input (SRC) in event logic operations.

|     |         |   |    |
|-----|---------|---|----|
| DI1 | RUN/RST | <input checked="" type="checkbox"/> CH1 |    |
| DI2 | None    | : CH1                                   |    |
| DI3 | None    | : CH1                                   | LG |
| DI4 | None    | : CH1                                   |    |

## ■ Restriction conditions when assigning DI

- ◆ RUN/RST is assigned (fixed) to DI1. This assignment cannot be changed.
- ◆ PTN2bit and PTN3bit can be assigned only to DI5 and DI8.
- ◆ PTN4bit and PTN5bit can be assigned only to DI5.

## ■ List of DI Types

| Mode    | Action   | No-action Conditions | Signal Detection |
|---------|--|----------------------|------------------|
| None    | No action (factory default)  | ----                 | ----             |
| RUN/RST | Switching of Run/Reset (when ON: Run execution)                          | None                 | Edge             |
| RST     | Forced Reset (when ON: Reset state)                                      | None                 | Level            |
| HLD     | Control suspension/restart (when ON: suspension state)                   | None                 | Level            |
| ADV     | Execute advance (when ON: execute advance)                               | HLD                  | Edge             |
| FIX     | Switching of FIX mode/Program mode (when ON: FIX mode)                   | None                 | Level            |
| MAN     | Switching of control output between auto/manual (when ON: manual)        | AT                   | Level            |
| LOGIC   | Logic operation input [exclusive port] (when ON: input ON)               | None                 | Level            |
| PTN2bit | Selection of start pattern No. by DI input (selectable from 3 patterns)  | FIX                  | Level            |
| PTN3bit | Selection of start pattern No. by DI input (selectable from 7 patterns)  | FIX                  | Level            |
| PTN4bit | Selection of start pattern No. by DI input (selectable from 15 patterns) | FIX                  | Level            |
| PTN5bit | Selection of start pattern No. by DI input (selectable from 20 patterns) | FIX                  | Level            |

Note 1 The corresponding DI action details cannot be executed while parameters listed in the "No-action Conditions" column in the List of DI Types Table are being executed.

Note 2 Signal detection timing:

Level input Action is maintained with DI input ON.

Edge input Action is executed by DI input ON, and is maintained even if DI input turns OFF. Action is canceled by DI input ON again.

Note 3 DI input must be held at ON or OFF for at least 0.1 sec. to detect DI input.

Note 4 Once a function is assigned to a DI, the same function cannot be set by the front panel keys as DI is given priority.

Note 5 When the same action is assigned to two or more DIs, the DI having the smallest No. is valid under the following conditions, and DIs having a larger No. are invalid:

- (1) When the same action is assigned to multiple DIs (however, valid if on different channels)  
For example, assignment DI2 becomes invalid when MAN is assigned to DI1 and DI2.
- (2) When action types (PTN2bit, PTN3bit, PTN4bit, PTN5bit) that use multiple DI terminals are assigned to multiple DIs (however, valid if on different channels)  
For example, assignment to DI8 becomes invalid when PTN3bit is assigned to DI5 and DI8.

Note 6 When action types (PTN2bit, PTN3bit, PTN4bit, and PTN5bit) that use multiple DI terminals are assigned, the assigned action of the DI to be used will be cleared depending on the assignment.

When DI5 is assigned to PTN5bit with MAN assigned to DI6, MAN assigned to DI6 is canceled as the start pattern No. will be assigned to DI6.

Note 7 When a DI assignment is canceled during DI execution, the currently executing action is continued (excluding LOGIC operation).

Note 8 For details on logic operation, see "12-4 Event Logic Operations".

Note 9 LOGIC cannot be set to CH.

### ■ Selection of start pattern No.

The start pattern No. can be selected by the external input.

To use this function, PTN2bit, PTN3bit, PTN4bit, or PTN5bit must be assigned to DI5, or PTN2bit or PTN3bit must be assigned to DI8, and the EXT lamp must be set to light.

#### Ex: To assign [PTN5bit] to DI5, and select start pattern No.5

The start pattern No. is automatically assigned from DI5 to DI9, and the key mark is displayed. To select start pattern No.5, short across DI COM (terminal No.44) and DI5 (terminal No.38), and DI7 (terminal No.40) according to the following table.

| DI<br>(terminal No.) | Start Pattern No. |   |   |   |   |   |   |   |   |   |    |    |    |    |    |    |    |    |    |    |    |
|----------------------|-------------------|---|---|---|---|---|---|---|---|---|----|----|----|----|----|----|----|----|----|----|----|
|                      | 0                 | 1 | 2 | 3 | 4 | 5 | 6 | 7 | 8 | 9 | 10 | 11 | 12 | 13 | 14 | 15 | 16 | 17 | 18 | 19 | 20 |
| DI5 (38)             |                   | * |   | * |   | * |   | * |   | * |    | *  |    | *  |    | *  |    | *  |    | *  |    |
| DI6 (39)             |                   |   | * | * |   |   | * | * |   |   | *  | *  |    |    | *  | *  |    |    | *  | *  |    |
| DI7 (40)             |                   |   |   |   | * | * | * | * |   |   |    |    | *  | *  | *  | *  |    |    |    |    | *  |
| DI8 (41)             |                   |   |   |   |   |   |   |   | * | * | *  | *  | *  | *  | *  | *  |    |    |    |    |    |
| DI9 (42)             |                   |   |   |   |   |   |   |   |   |   |    |    |    |    |    |    | *  | *  | *  | *  | *  |

\* mark indicates short across DI COM (44).

#### Note

- ◆ When start pattern No.0 is selected (DI input in OPEN state), the start pattern No. becomes No.1.

## 13-2 Analog Output

This function is optional and is not displayed when it is not installed.

All of the following assignments are possible for both Analog Output 1 (Ao1) and Analog Output 2 (Ao2).

### (1) Analog Output type

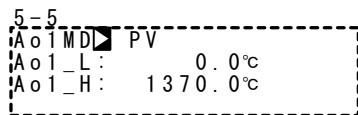

Setting range

PV, SV, DEV, OUT1, CH2\_PV,  
CH2\_SV, CH2\_DEV, OUT2

Initial value

Ao1: PV  
Ao2: SV

PV Measured value (CH1)

CH2\_PV Measured value (CH2)

SV Target set value (CH1)

CH2\_SV Target set value (CH2)

DEV Deviation of PV and SV (CH1)

CH2\_DEV Deviation of PV and SV (CH2)

OUT1 Control Output 1

OUT2 Control Output 2

### (2) Scaling Analog Output

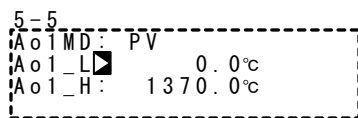

#### Setting ranges and defaults

(Ao1\_L < Ao1\_H, or Ao2\_L < Ao2\_H)

| Description  | Analog output Type        | Setting Range          | Default                             |
|--|---------------------------|------------------------|-------------------------------------|
| Ao1_L analog output 1<br>lower limit scaling<br>Ao2_L analog output 2<br>lower limit scaling   | PV, SV,<br>CH2_PV, CH2_SV | Within measuring range | Setting range<br>lower limit value  |
|  | DEV, CH2_DEV              | -100.0 to 100.0%       |                                     |
|  | OUT1, OUT2                | 0.0 to 100.0%          | 0.0%                                |
| Ao1_H analog output 1<br>higher limit scaling<br>Ao2_H analog output 2<br>higher limit scaling | PV, SV,<br>CH2_PV, CH2_SV | Within measuring range | Setting range<br>higher limit value |
|  | DEV, CH2_DEV              | -100.0 to 100.0%       |                                     |
|  | OUT1, OUT2                | 0.0 to 100.0%          | 100.0%                              |

### 13-3 Setting the Heater Break/Heater Loop Alarms

This function is optional and is not displayed when it is not available.

This function outputs an alarm when the heater has burned out during control (heater break) or when some trouble on the final control element causes a heater current to flow when output is OFF (heater loop error).

Alarm output is assigned to EVENT/DO (external output), and HBA (heater break alarm) or HLA (heater loop alarm) is assigned for use.

Heater Break Alarm and Heater Loop Alarm can be used when Control Output 1 or Control Output 2 is a contact (Y) or SSR drive voltage (P).

These alarms cannot be used if control output is current (I) or voltage (V).

Hysteresis is fixed to 0.2A.

#### (1) Connecting the Current Transformer (CT)

Pass the load wire through the hole of the CT (provided with this device).

Wire from the CT terminal to the CT input terminal on this device.

The wire has no polarity.

For 30A CT CTL-6-S

For 50A CT CTL-12-S36-8

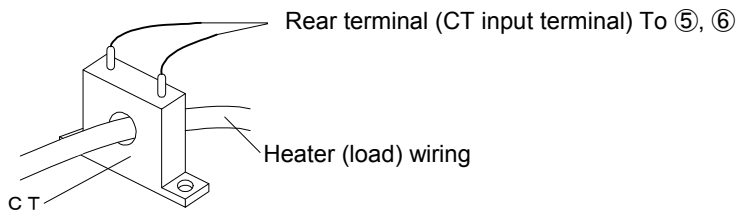

#### (2) Heater current monitor

The monitor displays the current value detected by the current transformer (CT).

```

5-7
Heater [ 0.0A ]
HBA: OFF
HLA: OFF
HBM: Lock HB: OUT1

```

Display range 0.0 to 50.0 A

- ◆ "HB\_HH" is displayed on the LCD display screen when the detection current exceeds 55.0A.
- ◆ "—" is displayed on the LCD display screen when the current cannot be detected.

#### (3) Heater Break Alarm current (HBA)

An alarm is output when the current of the load wire is smaller than the preset value.

```

5-7
Heater [ 0.0A ]
HBA: OFF
HLA: OFF
HBM: Lock HB: OUT1

```

Setting range OFF, 0.1 to 50.0 A  
Initial value OFF

#### Note

- ◆ To use Heater Break Alarm, HBA must be assigned for EVENT/DO in EVENT/DO group.

**(4) Heater Loop Alarm current (HLA)**

An alarm is output when the current of the load wire is greater than the preset value.

```

5=7
Heater [ 0.0A ]
HBA: OFF
HLA: OFF
HBM: Lock HB: OUT1

```

Setting range      OFF, 0.1 to 50.0 A  
Initial value      OFF

**Note**

- ♦ To use Heater Loop Alarm, HLA must be assigned for EVENT/DO in EVENT/DO group.

**(5) Heater Break/Heater Loop Alarm mode (HBM)**

You can select the real mode or the lock mode as the alarm output mode.

```

5=7
Heater [ 0.0A ]
HBA: OFF
HLA: OFF
HBM: Lock HB: OUT1

```

Setting range      Real, Lock  
Initial value      Real

- Real      Once the alarm is output, alarm output is canceled when the heater current returns to normal.
- Lock      Once the alarm is output, alarm output is locked (fixed), and is output continuously even if the heater current returns to normal.  
Alarm output can be canceled by setting HBA/HLA to OFF or turning the power OFF.

**(6) Heater Break detection Selection (HB)**

Select the control output at which Heater Break is detected.

This parameter can be set when another choice besides the 1-output specification is selected, and specified either Y/Y, P/P, Y/P, or P/Y for output 1/output 2.

```

5=7
Heater [ 0.0A ]
HBA: OFF
HLA: OFF
HBM: Lock HB: OUT1

```

Setting range      OUT1, OUT2  
Initial value      OUT1

## 13-4 Communication

### (1) Setting communication

For details, refer to the separate manual "FP23 Series Programmable Controller Communications (Interface) (RS-232C/RS-485) Instruction manual (Detailed version)." This section explains only setting items.

5-8

|          |          |
|----------|----------|
| COM PROT | SHIMADEN |
| ADDR:    | 1        |
| BPS :    | 9600     |
| MEM :    | EEP      |

PROT: Communication protocol

Setting range SHIMADEN, MOD\_ASC, MOD\_RTU

Initial value SHIMADEN

ADDR: Communication address

Setting range 1 to 98

Initial value 1

BPS: Communication speed

Setting range 2400, 4800, 9600, 19200 bps

Initial value 9600 bps

MEM: Communication memory mode

Setting range EEP, RAM, R\_E

Initial value EEP

5-9

|          |       |
|----------|-------|
| COM DATA | 7     |
| PARI:    | EVEN  |
| STOP:    | 1     |
| DELY:    | 10 ms |

DATA: Communication data length

Setting range 7, 8

Initial value 7

PARI: Communication parity

Setting range EVEN, ODD, NONE

Initial value EVEN

STOP: Communication stop bit

Setting range 1, 2

Initial value 1

DELY: Communication delay time

Setting range 1 to 50 ms

Initial value 10 ms

5-10

|          |            |
|----------|------------|
| COM CTRL | STX_ETX_CR |
| BCC:     | ADD        |

CTRL: Control code

Setting range STX\_ETX\_CR, STX\_ETX\_CRLF, @:\_:\_CR

Initial value STX\_ETX\_CR

BCC: Block Check Character

Setting range ADD, ADD\_two's cmp, XOR, None

Initial value ADD

**(2) Communication Mode (COM)**

Select whether or not to set or change various data using the front panel keys (local) or by communication (option).

1-1

|      |       |    |
|------|-------|----|
| AT : | OFF   | CH |
| MAN: | OFF   | 1  |
| COM  | LOCAL |    |

|      |       |    |
|------|-------|----|
| AT : | OFF   | CH |
| MAN: | OFF   | 1  |
| COM  | LOCAL |    |

Setting range LOCAL, COM  
Initial value LOCAL

In the LOCAL mode, the key sign is displayed at the communication selection, indicating that changing from LOCAL (local) to COM (communication) by the front panel keys isn't possible.

Even in the LOCAL mode, the Communication mode can be changed from LOCAL to COM by sending commands to the FP23 from the host.

In the COM mode, the Communication mode can also be changed from COM to LOCAL by operating the front panel keys.

LOCAL Settings can be made using the front panel keys.  
(Settings cannot be made by communication.)

COM Settings can be made by communication.  
(Settings cannot be made by the front panel keys.)



# 14 KEY LOCK SETTING

## 14-1 Setting Key Lock

### (1) Displaying the key lock screen

To call up the LOCK, etc. screen group (group 8) from the basic screen, press the **GRP** key.

Press the **SCRN** key in the LOCK, etc. screen group to switch to the screens for making and changing setups.

Select parameters in screens by pressing the **↶** key.

Set parameters by pressing the **◀** **▼** or **▲** key, and press the **ENT** key to fix and register settings.

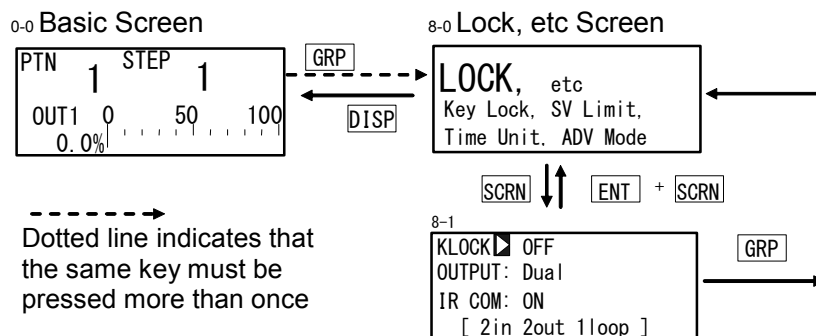

### (2) Key lock

When Key lock is applied, **🔒** (key mark) is displayed at the relevant parameter on the LCD screen and the parameter cannot be set or changed.

|     |  |               |                          |
|-----|--|---------------|--------------------------|
| 8-1 | KLOCK <b>🔒</b> OFF<br>OUTPUT: Dual<br>IR COM: ON<br>[ 2in 2out 1loop ] | Setting range | OFF, LOCK1, LOCK2, LOCK3 |
|     |  | Initial value | OFF                      |

- LOCK1 Locks parameters other than SV-related, AT, MAN, and EVENT/DO parameters.
- LOCK2 Locks parameters other than SV-related parameters.
- LOCK3 Locks all parameters. (excluding the key lock parameter itself)

For details on parameters that are locked, see "18 List of Parameters."

This page left intentionally blank.

# 15 MONITORING, EXECUTING & STOPPING OPERATION

To execute Program control or Fixed value control, the basic screen (No.0-0) must be displayed.

When another screen is displayed, press the **DISP** key to move to the basic screen.

## 15-1 Flow of Basic Screen under 2-loop Specification

As this section indicates that the basic screen contents and transition, you may skip this section in case another choice besides the 2-loop specification is selected.

Under the 2-loop specification, three Display Modes are offered as the Basic screen on the LCD screen; Display mode 1: Screen 0-0 - Basic screen for CH1, Display mode 2: Screen 0-0A - Basic screen for CH2, and Display mode 3: Screen 0-0B - PV Basic screen.

By pressing the **DISP** key, the LCD screen will be switched to another to display the desired channel which is under control operation.

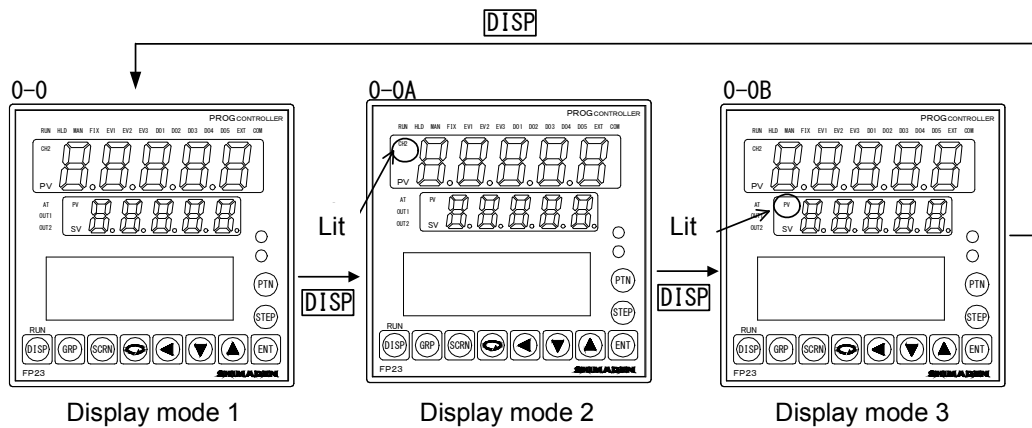

The channel number and the contents on the Basic screen are linked to the PV display, SV display, and status lamps (RUN, HLD, MAN, FIX, EXT, AT). For example, when the CH2 lamp does not illuminate, CH1 information is displayed, or when the CH2 lamp illuminates, CH2 information is displayed.

By using **DISP** key Display/channel mode switching is available at the Basic screen only. When the Display mode 3 is selected, PV of CH1 is displayed on the PV display, PV of CH2 is displayed on the SV display, and statuses of CH1 are reflected on the status lamps respectively.

### ■ Information offered according to Display modes on 7-segment LED/Status lamps

|                      | Display mode 1 | Display mode 2 | Display mode 3 |
|----------------------|----------------|----------------|----------------|
| Status lamps         | CH1            | CH2            | CH1            |
| 7-segment LED, upper | CH1 PV         | CH2 PV *1      | CH1 PV         |
| 7-segment LED, lower | CH1 SV         | CH2 SV         | CH2 PV *2      |

\*1 CH2 lamp on PV display lits.

\*2 PV lamp on SV display lits

Even if the Basic screen transits to another by pressing the **GRP** key, PV/SV display shows values for the current channel. The Basic screen, which returns by pressing a **DISP** key, indicates the contents that are shown just before the pressing the **GRP** key.

## 15-2 Operations in Basic Screen

The following operations are possible in the basic screen in a reset state:

- (1) Setting the start pattern
- (2) Setting the start step
- (3) Setting FIX mode (between the Program mode and the FIX mode)
- (4) Changing FIX SV value (can be changed while execution)
- (5) Start/Stop Program control/Fixed value control

### (1) Setting the start pattern

Set the start pattern before the program is started.

When the **PTN** key is pressed in Basic screen group top screen, the program pattern No. on the LCD display blinks and is incremented. (It can also be changed by the **▲** or **▼** key if it is blinking.)

When you press the **ENT** key after changing the program pattern No. to fix the setting, blinking stops.

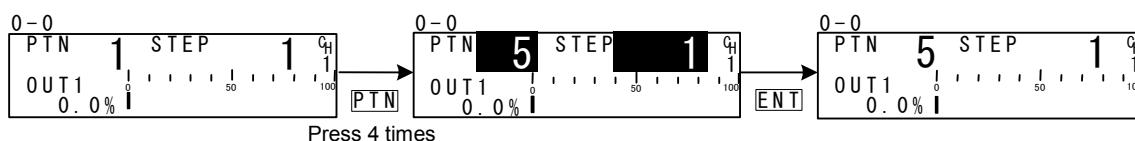

### (2) Setting the start step

Set the start step before the program is started.

When the **STEP** key is pressed in Basic screen group top screen, the program step No. on the LCD display blinks and is incremented. (It can also be changed by the **▲** or **▼** key if it is blinking.)

When you press the **ENT** key after changing the program step No. to fix the setting, blinking stops.

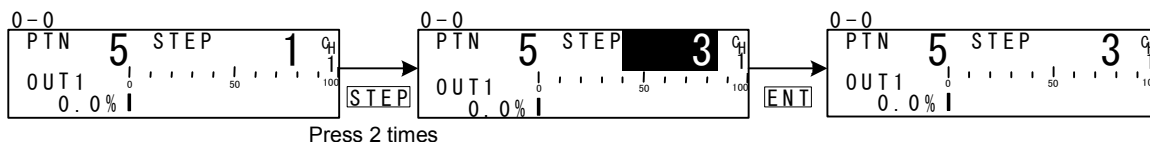

When "0" is set to the start step, that pattern is not executed. To execute control, set a value other than "0" to the start step.

**(3) Setting the FIX mode**

When the **[PTN]** key is pressed in Basic screen group top screen, the program pattern No. on the LCD display blinks and is incremented. (It can also be changed by the **[▲]** or **[▼]** key if it is blinking.)

When "F" is selected, and the **[ENT]** key is pressed to fix the setting, blinking stops.

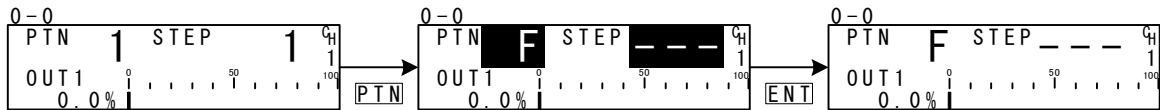
**Note**

- ◆ When the mode is changed from the Program mode to the FIX mode, the move operation changes depending on the FIX MOVE setting.

For details, see "10-4 FIX MOVE."

**(4) Setting the FIX SV value (only in FIX mode)**

In the FIX mode, pressing the **[◀]**, **[▲]** or **[▼]** key in Basic screen group top screen causes the lowermost digit in the SV display to blink.

Press the **[◀]** key to move the blinking section on the numerical value to the digit to be changed, and press the **[▲]** or **[▼]** key to change the SV value. After changing the SV value, press the **[ENT]** key to fix the setting. The blinking section on the numerical value stops.

### 15-3 Displaying the Step No. and SV

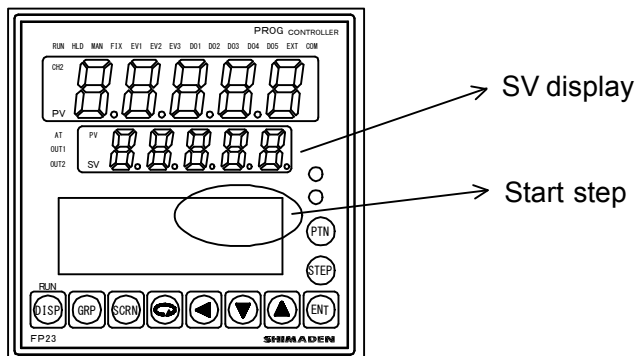

The following table shows the relationship between the start step No. in Reset state and the SV display.

| Start Step No. | SV display         |          |
|----------------|--------------------|----------|
|                | Program mode       | FIX mode |
| 0              | Starting SV        |          |
| 1              | Starting SV        |          |
| 2 to 400       | Previous step's SV |          |
| ---            |                    | FIX SV   |

### 15-4 How to Start / Stop Control

Check the following again before starting control:

1. The LCD display shows the Basic screen (In 2-loop specification, the Basic screen of the controlling channel)
2. Confirm if the FP23 is in the desired control mode (Program or FIX).
3. The LCD display shows the desired start pattern/start step.

Start control operation after confirming these items.

In the Basic screen (In 2-loop specification, the Basic screen of the controlling channel), press the **ENT** + **DISP** keys, to start (RUN lamp lit) / stop control.

## 16 OPERATIONS DURING CONTROL

### 16-1 Monitoring Control

#### (1) Basic screen

During program control, the currently executing pattern and step are displayed. During fixed value control, "F" is displayed on the pattern display, and "- - -" is displayed on the step display indicating that the display is off.

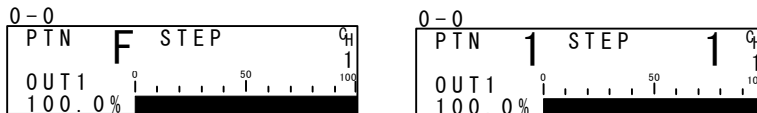

#### (2) Output value display

The output values of Control Output 1 (OUT1) and Control Output 2 (OUT2: option) are displayed on the upper and lower sections, respectively, as a % and a bar graph. In the 1-output specification, OUT2 is not displayed.

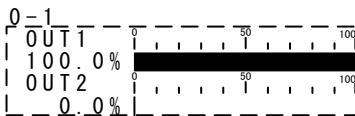

During manual output, OUT1 or OUT2 can be selected by the key, and output can be adjusted by operating the , or key. For details, refer to "16-3 Switching Auto/Manual of Control Output".

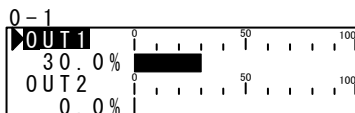

#### (3) PV monitor

This screen is shown only in case of 2-input operation.

This is a monitoring screen to check input 1 or input 2 PV value, different from execution PV value.

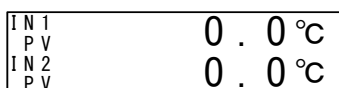

**(4) Status monitor**

This screen is displayed only in case of 2-loop specification.  
 This is a status monitor screen for the another channel, different from Basic screen.

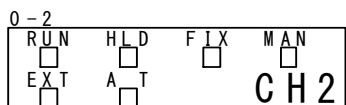

When any condition is detected, each of the  located subjacent to each parameter display will blink, or  is lit reversed.

- RUN Lights during control is being executed. Blinks during program start delay time (PRG.Wait).
- HLD Lights when the program is paused in Program mode. Blinks when the pause caused by an input error in the Program mode or in the Fix mode.
- FIX Lights in the FIX mode.
- MAN Blinks when control output is set to manual operation (MAN).
- EXT Lights when start pattern No. selection (PTN2bit, PTN3bit, PTN4bit, PTN5bit) are set to DI5 to DI8.
- AT Lights during auto tuning standby. Blinks during auto tuning execution.

**(5) Monitoring program status**

This screen shows program execution for CH1 and CH2 status.  
 CH1 status is shown in the upper low, CH2 status is shown in the lower low.

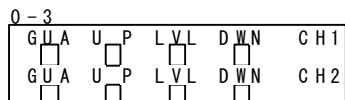

- GUA Lights in guarantee soak.
- UP Lights at execution of ascending step.
- LVL Lights at execution of flat step.
- DWN Lights at execution of descending step.

**(6) Monitoring the remaining step time**

This screen is displayed only during program control.  
 The remaining time of the currently executing step is displayed. The display returns to the basic screen when a stop (RST) is input by DI or when the mode has moved to the FIX mode by DI.

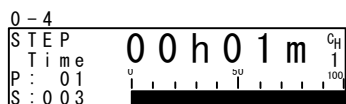

**(7) Monitoring the program**

This screen graphically displays the program pattern.  
 With programs exceeding ten steps, you can scroll the monitor display in 1-step increments by pressing the  key to display the next ten steps, or pressing the  key to display the previous ten steps.

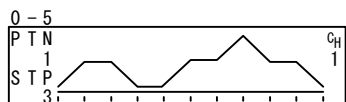



**(8) Monitoring the pattern link**

This screen is displayed only during program control.  
 The pattern link settings and execution state are displayed.  
 The currently executing pattern No. is displayed blinking.

| 0 - 6 |           |     |     |         |                |
|-------|-----------|-----|-----|---------|----------------|
| P T N | L i n k   |     |     |         | C <sub>H</sub> |
| 1 -   | 2 -       | 4 - | 3 - | 5 - 1 0 | 1              |
| 1 -   | 5 - 1 0 - | 2 - | 3 - | 3 -     | 2              |
| 9 -   | 7 -       | 4 - | 1 - | 1 -     | 3 - 3          |

**(9) Monitoring information during control execution**

This screen is displayed only during control execution.  
 The states of the following four parameters are displayed.  
 Note, however, that only the PID No. is displayed during fixed value control (FIX).

| 0 - 7 |         |     |   |                |
|-------|---------|-----|---|----------------|
| P T N | L N K : | 1 / | 1 | C <sub>H</sub> |
| P T N | R E P : | 1 / | 1 | 1              |
| S T P | L O P : | 1 / | 1 |                |
| P I D | N o     | 1   |   |                |

- PTN LNK    Indicates the pattern link execution count and setting count.  
 PTN REP    Indicates the pattern execution count and setting count.  
 STP LOP    Indicates the execution count and setting count of the step loop.  
 PID No.    Indicates the PID No. currently in use.

## 16-2 Executing and Stopping Auto Tuning

Auto tuning (AT) can be executed and stopped.

During execution of auto tuning, the AT LED indicator or  of status monitor (screen 0-3) blinks, lights during auto tuning standby, and go out when auto tuning ends or stops.

|     |  |       |    |
|-----|--|-------|----|
| 1-1 | AT <input checked="" type="checkbox"/> | OFF   | CH |
|     | MAN:                                   | OFF   | 1  |
|     | COM宇                                   | LOCAL |    |

Setting range ON, OFF

Initial value OFF

### **What is "auto tuning?"**

Auto tuning automatically calculates the optimum PID constants by the limit cycle method so that control is executed using these values.

Note

- ◆ As auto tuning is affected by the output limiter during execution, set the lower and higher limit values of the control output value before executing auto tuning. (Normally, set the lower limit value to 0% and the higher limit value to 100%.)

### ◆Auto tuning cannot be executed

|                               | Program Mode                   | FIX Mode                       |
|-------------------------------|--------------------------------|--------------------------------|
| Reset state (RST)             | Auto tuning cannot be executed | Auto tuning cannot be executed |
| Manual output (MAN)           | Auto tuning cannot be executed | Auto tuning cannot be executed |
| Zone PID set to "PV"          | Auto tuning cannot be executed | Auto tuning cannot be executed |
| PV value scale over           | Auto tuning cannot be executed | Auto tuning cannot be executed |
| PID P=OFF<br>(ON-OFF control) | Auto tuning standby            | Auto tuning cannot be executed |

### ◆Auto tuning end conditions

|   | Program Mode       | FIX Mode           |
|---|--------------------|--------------------|
| When the RUN state changes to the reset (RST) state                 | End of auto tuning | End of auto tuning |
| When output has elapsed for about 200 minutes in a 0% or 100% state | End of auto tuning | End of auto tuning |
| At power interruption   | End of auto tuning | End of auto tuning |
| When PID operation has ended  | ---                | End of auto tuning |
| When computation of all PID Nos. (No.1 to No.10) has ended          | End of auto tuning | ---                |
| When PV value has exceeded the scale                                | End of auto tuning | End of auto tuning |

### ◆About auto tuning during program control

Once AT has been executed, the program judges whether the current step is a ramp section or a flat section, and stands by for the next step in an AT standby state (lamp lit) on ramp sections. At flat sections, AT is executed (lamp blinks) using the PID No. of that step.

Note, however, that under the conditions, the above operation sometimes is not performed.

- (1) If the FP23 is in Hold state, AT is executed even if the current step is a ramp section.
- (2) AT forcibly ends at PV scale over.
- (3) The state changes to the AT standby state when P=OFF (ON-OFF control).
- (4) For PID Nos. obtained by AT execution once and set with appropriate PID values, the state is the AT standby state even on flat sections until the program ends, and AT is not executed as long as AT is not performed again.

The following shows an example of AT execution at Step3.

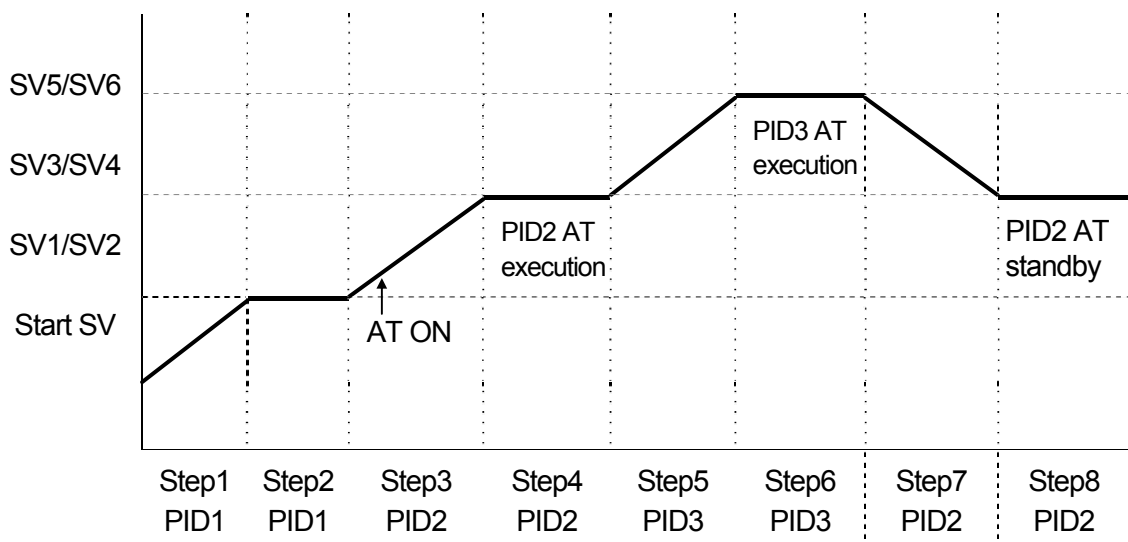

Step3 AT is in a standby state as the step is a ramp section. (AT LED lit)

Step4 AT of flat section PID2 is executed (AT LED blinks), and becomes a standby state at the remaining time (AT LED lit).

Step5 AT is in a standby state as the step is a ramp section. (AT LED lit)

Step6 AT of flat section PID3 is executed (AT LED blinks), and becomes a standby state at the remaining time (AT LED lit).

Step7 AT is in a standby state as the step is a ramp section. (AT LED lit)

Step8 AT is in a standby state (AT LED lit) as computation of PID2 has ended at Step4.

\*1 AT also ends (AT LED Out) at program end (Step8).

\*2 In the case of this example, AT of PID1 is not performed.

Note

- ◆ When there is not enough step execution time at flat sections, and AT does not end, AT execution of that No. is carried out to the next time.

### ◆About auto tuning during fixed value control (FIX)

During FIX control, the AT lamp blinks from the moment that AT is started. When AT ends, the AT lamp automatically goes out.

### 16-3 Switching Auto/Manual of Control Output

Normally, automatic operation is performed. However, use this item to manually set control output, for example, during device testing.

During manual output, note that the set value is continually output and feedback control is not performed.

During manual output, the MAN monitor lamp and status monitor (screen 0-2) are displayed blinking.

| 1-1 |       |    |
|-----|-------|----|
| AT  | OFF   | CH |
| MAN | OFF   | 1  |
| COM | LOCAL |    |

Setting range      OFF, ON  
Initial value        OFF

The manual execution conditions (common to front panel keys and external switch input) are as follows:

- (1) AT must not be in progress.
- (2) The FP23 must not be in a Reset (RST) state.

#### (1) Manual output operations

In a 1-output specification, the output value of OUT2 and the output bar graph are not displayed on the screen.

| 1-1 |       |    |
|-----|-------|----|
| AT  | OFF   | CH |
| MAN | ON    | 1  |
| COM | LOCAL |    |

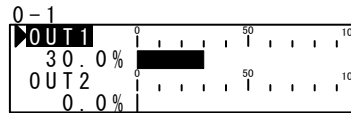

1. In the setup screen (1-1), select MAN (manual) using the cursor, and select ON to register manual output.
2. Next, to perform control output manually, move to the basic screen (group 0) by the **DISP** key, and move to the output value display (0-1) screen by the **SCRN** key. At this time, make sure that the cursor (█) is displayed at the top left of the LCD screen.
3. You can select OUT1 or OUT2 by the **↻** key, and adjust the output by the **◀**, **▲** or **▼** key.  
There is no need to register and fix settings by the **ENT** key.

#### Note

In the case of 2-loop specification, switching to Manual control mode has to be done in each channel.

**(2) Simple key-based manual output operations**

In the output value display screen (0-1), you can switch automatic/manual by pressing the **ENT** + **▲** keys for OUT1, or the **ENT** + **▼** keys for OUT2.

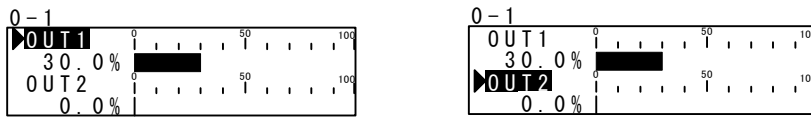

**ENT** + **▲** or **ENT** + **▼**

**16-4 Temporarily Holding (HLD) and Resuming Program Execution**

Hold is a function for temporarily holding program control. When this function is set to ON, HLD is executed, and when it is set to OFF, HLD is canceled. During HLD execution, the HLD monitor lamp, and  of the status monitor (screen 0-2) are lit.

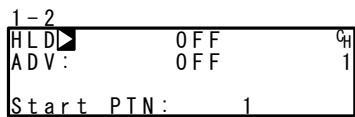

Setting range      OFF, ON  
Initial value      OFF

In the following example, the remaining Step5's period is used to reach SV5 after HLD is canceled.

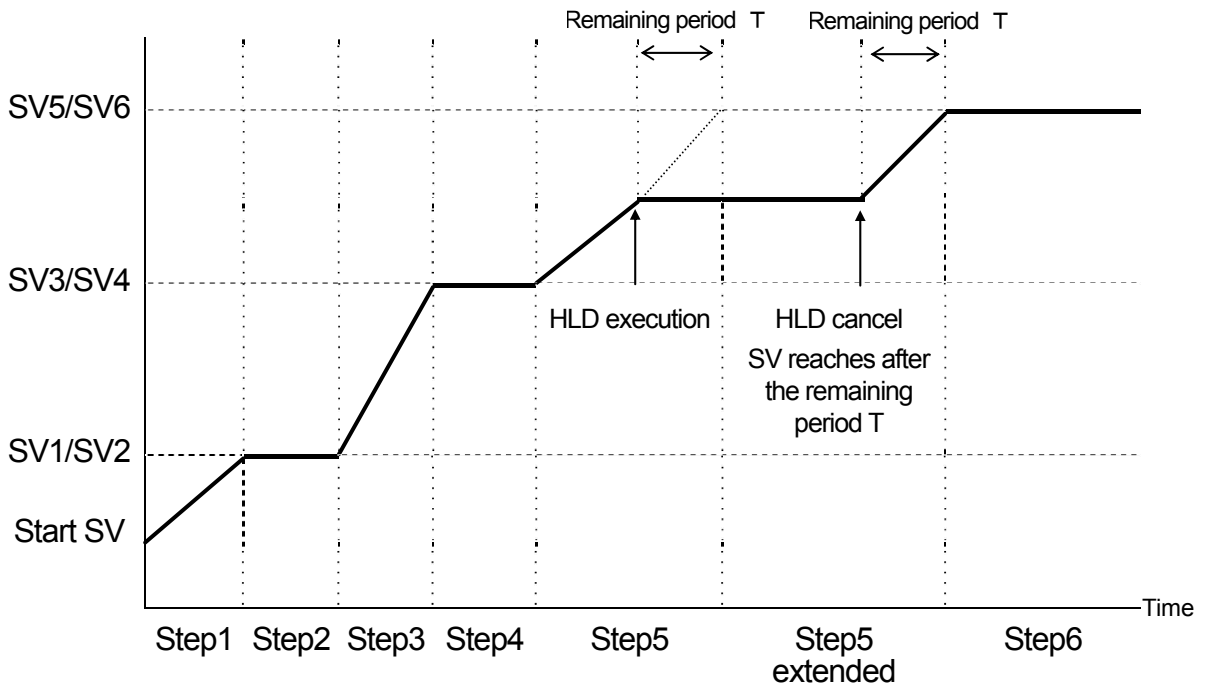

- \*1 HLD is enabled even in the guarantee soak.
- \*2 ADV cannot be executed during HLD.
- \*3 HLD operation by key entry or communication is enabled only when DI is not assigned. (DI input is given priority.)
- \*4 When a program is executed with HLD DI input ON, program execution is dependent on the SV value of the PV start function.  
Ex:            When PV start is ON, hold by SV value of PV start  
                  When PV start is OFF, hold by start SV
- \*5 During HLD, changes to parameters are not reflected until HLD is canceled even if start V, step SV and time signal related parameters are changed.

### 16-5 Executing Advance (ADV)

Advance is a function for forcibly moving to the next step (or time) from the current step (or time) during program execution.

1. Step move: Program advance in step units (single steps).
2. Time move: Program advance in time units.

For details on the setting of move action by ADV execution and ADV time when time move is set, see "9-1 (5), Advance mode," and "9-1 (6), Advance time."

|            |     |    |
|------------|-----|----|
| 1-2        |     |    |
| HLD:       | OFF | CH |
| ADV        | OFF | 1  |
| Start PTN: | 1   |    |

Setting range ON, OFF  
Initial value OFF

**Note**

- ◆ ADV is disabled for about two second after ADV is executed.
- ◆ In a guarantee soak (GUA) state, GUA is canceled on both the step and time, and the program only moves to the next step.
- ◆ Advance cannot be executed during a hold (HLD).

**Example) Move by step (forcibly end step 5 and move to step 6)**

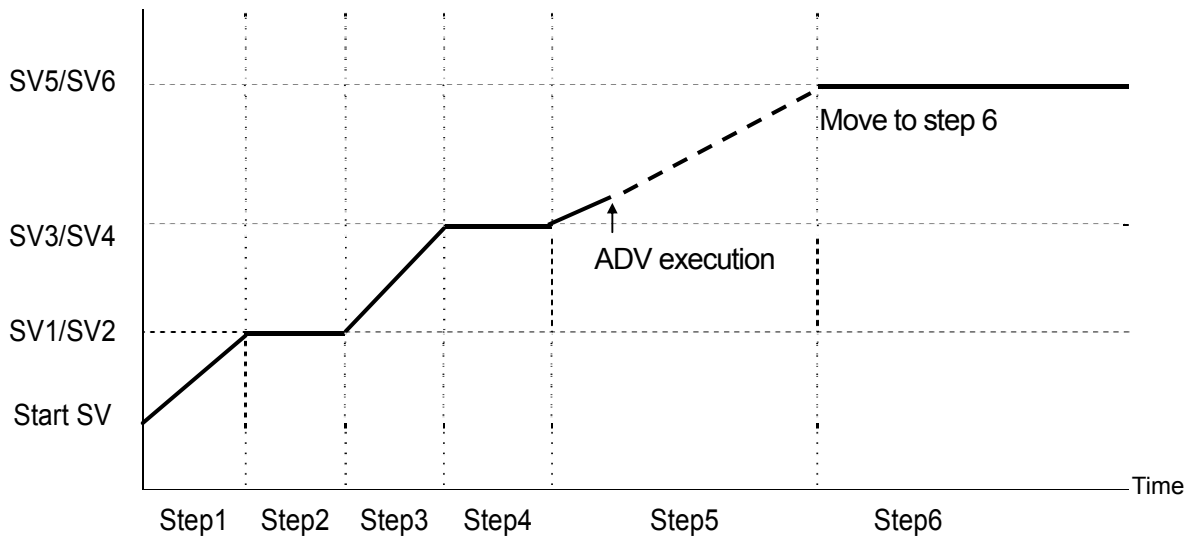

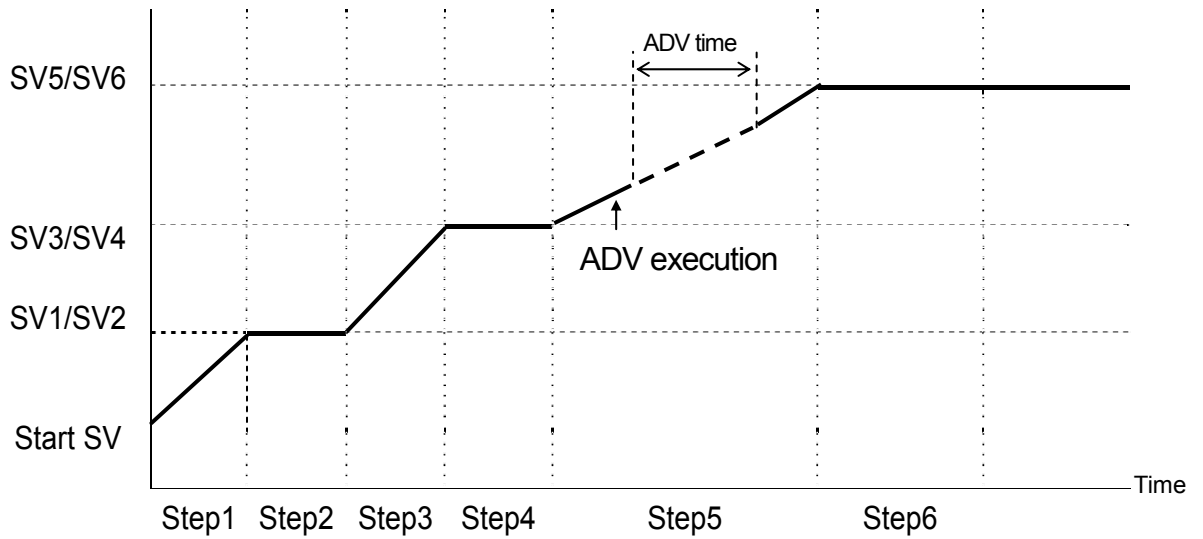
**Example) Move by time (move by ADV time only)***Note*

- ◆ In time selection, when the ADV time is greater than the remaining time of that step, advance beyond the next step is not performed, and the program only advances to the next step in the same way as in step selection.

This page left intentionally blank.



## 17 ERROR DISPLAYS

### 17-1 Operation Check Abnormalities at Power ON

This device displays the following error codes on the PV display when an error is detected.

| Display          | Cause             |  |
|------------------|-------------------|--|
| <i>E - r o ñ</i> | ROM error         | In any of the states shown on the left, all outputs turn OFF or become 0%. |
| <i>E - r A ñ</i> | RAM error         |  |
| <i>E - E E P</i> | EEPROM error      |  |
| <i>E - A d 1</i> | Input 1 A/D error |  |
| <i>E - A d 2</i> | Input 2 A/D error |  |
| <i>E - S P c</i> | Hardware error    |  |

### Request

- ◆ If any of the messages shown in the table are displayed, repair or replacement is required. Immediately turn the power OFF, and contact your dealer.

## 17-2 PV Input Abnormalities

When a PV input-related abnormality is detected during execution of control on this device, the following error codes are displayed on the PV display.

| Display      | Cause  |
|--------------|--|
| <i>Sc.LL</i> | The PV value exceeded the measuring range lower limit (-10%FS).  |
| <i>Sc.HH</i> | The PV value exceeded the measuring range higher limit (+110%FS).  |
|              | RTD Burnout  |
|              | Thermocouple Burnout   |
| <i>b----</i> | One or two RTD-B burnout, or all leads of the RTDs burnout.<br>Action of this device in this case is PV moving excessively towards the higher limit. |
| <i>EJ.LL</i> | Reference junction compensation (-20°C) is at the lower limit.<br>(thermocouple input)   |
| <i>EJ.HH</i> | Reference junction compensation (+80°C) is at the higher limit.<br>(thermocouple input)  |

### Request

- ◆ Check input or the heater lead when the above messages are displayed. If the input or the heater lead is not in error and there is another probable cause, contact your dealer.

## 17-3 Heater Current Abnormalities (option)

When a heater current abnormality is detected during execution of control on this device the following error codes are displayed on the LCD.

| Display      | Cause                             |
|--------------|-----------------------------------|
| <i>Hb.HH</i> | The heater current exceeds 55.0A. |

## 18 LIST OF PARAMETERS

This chapter lists all of the parameters used by the FP23.  
Parameters that cannot be set by the user are not listed.

|                         |  |
|-------------------------|--|
| Symbol                  | Indicates the parameter symbol displayed on the LCD screen.  |
| (CH1), (CH2)            | Related only to a 2-loop specification.  |
| Description of Function | Indicates the display or setup details.  |
| Setting range           | Indicates the range of parameters or numerical values that can be set.   |
| Initial Value           | Indicates the factory default.<br>(Excluding instances where this device is shipped with values customized to customer specified values)   |
| Lock                    | Number indicates the level at which key lock is valid.   |
| *                       | Indicates a parameter that may be initialized when one of a range setting, digit setting or PV scaling setting has been changed.<br>Parameters marked by * may need to be confirmed again when the above settings have been changed. |

### 18-1 Execution Screen Group (group 1)

| Symbol                     | Description of Function      | Setting Range                                       | Initial Value | Lock |
|----------------------------|------------------------------|---|---------------|------|
| AT                         | Auto Tuning                  | ON/OFF  | OFF           | 2    |
| MAN                        | * Manual output              | ON/OFF  | OFF           | 2    |
| COM                        | Communication mode           | LOC: Local settings<br>COM: Communications settings | LOC           | 2    |
| HLD                        | Hold                         | ON/OFF  | OFF           | 1    |
| ADV                        | Advance                      | ON/OFF  | OFF           | 1    |
| Start PTN                  | Start pattern No.            | 1 to 20   | 1             | 1    |
| PTN Link Reps              | Pattern link execution count | 0 to 9999   | 0             | 1    |
| Link Format<br>1st to 20th | Pattern link settings        | 0 to assigned pattern<br>higher limit               | 0             | 1    |
| FIX MODE                   | FIX mode selection           | ON/OFF  | OFF           | 1    |
| FIX SV                     | * FIX SV value setting       | Within SV limit setting<br>range                    | 0 digit       | 3    |
| FIX PID                    | FIX PID No. selection        | 1 to 10   | 1             | 1    |
| FIX MOVE                   | FIX move selection           | EXE<br>EXE/STBY<br>EXE/TRCK                         | EXE           | 1    |

| Symbol                           | Description of Function     | Setting Range   | Initial Value   | Lock |
|----------------------------------|-----------------------------|---|---|------|
| FIX EV Set Point<br>EV1 to EV3 * | FIX EV action point setting | DEV_Hi: -25000 to 25000 digit<br>DEV_Low: -25000 to 25000 digit<br>DEV_Out: 0 to 25000 digit<br>DEV_In: 0 to 25000 digit<br>PV_Hi: Within measuring range<br><br>PV_Low: Within measuring range | 25000 digit<br>-25000 digit<br>25000 digit<br>25000 digit<br>Measuring range higher limit value<br>Measuring range higher limit value | 2    |
| FIX DO Set Point<br>DO1 to DO9 * | FIX DO action point setting | DEV_Hi: -25000 to 25000 digit<br>DEV_Low: -25000 to 25000 digit<br>DEV_Out: 0 to 25000 digit<br>DEV_In: 0 to 25000 digit<br>PV_Hi: Within measuring range<br><br>PV_Low: Within measuring range | 25000 digit<br>-25000 digit<br>25000 digit<br>25000 digit<br>Measuring range higher limit value<br>Measuring range higher limit value | 2    |

## 18-2 Program Screen Group (group 2)

| Symbol                       | Description of Function | Setting Range   | Initial Value   | Lock |
|------------------------------|-------------------------|---|---|------|
| Num.of STEP                  | Number of steps         | 0 to assigned step higher limit   | 20  | 1    |
| Start STEP                   | Start step              | 0 to number of steps  | 1   | 1    |
| Start SV *                   | Start SV                | Within SV limiter setting range   | 0 digit   | 3    |
| PTN Repls                    | Pattern execution count | 1 to 9999 times   | 1   | 1    |
| Loop Setup                   |                         |   |   |      |
| Start                        | Start step No.          | 1 to number of steps  | 1   | 1    |
| End                          | End step No.            | 1 to number of steps  | 1   | 1    |
| Repls                        | Execution count         | 1 to 9999 times   | 1   | 1    |
| GUARantee Soak               |                         |   |   |      |
| Zone *                       | Guarantee soak zone     | OFF, 1 to 9999 digit  | OFF   | 1    |
| Time *                       | Guarantee soak time     | 00: 00 to 99: 59  | 00: 00  | 1    |
| PV Start                     | PV start                | ON/OFF  | OFF   | 1    |
| EV Set Point<br>EV1 to EV3 * | EV action point setting | DEV_Hi: -25000 to 25000 digit<br>DEV_Low: -25000 to 25000 digit<br>DEV_Out: 0 to 25000 digit<br>DEV_In: 0 to 25000 digit<br>PV_Hi: Within measuring range<br><br>PV_Low: Within measuring range | 25000 digit<br>-25000 digit<br>25000 digit<br>25000 digit<br>Measuring range higher limit value<br>Measuring range higher limit value | 2    |

| Symbol                       | Description of Function | Setting Range   | Initial Value   | Lock |
|------------------------------|-------------------------|---|---|------|
| DO Set Point<br>DO1 to DO9 * | DO action point setting | DEV_Hi: -25000 to 25000 digit<br>DEV_Low: -25000 to 25000 digit<br>DEV_Out: 0 to 25000 digit<br>DEV_In: 0 to 25000 digit<br>PV_Hi: Within measuring range<br><br>PV_Low: Within measuring range | 25000 digit<br>-25000 digit<br>25000 digit<br>25000 digit<br>Measuring range higher limit value<br>Measuring range higher limit value | 2    |
| TS1 to TS8                   |                         |   |   |      |
| ON STEP                      | Time signal ON step     | OFF, 1 to number of steps   | OFF   | 1    |
| ON Time                      | Time signal ON time     | 00:00 to 99:59  | 00:00   | 1    |
| OFF STEP                     | Time signal OFF step    | OFF, 1 to number of steps   | OFF   | 1    |
| OFF Time                     | Time signal OFF time    | 00:00 to 99:59  | 00:00   | 1    |

### 18-3 Step Screen Group (group 2S)

| Symbol         | Description of Function | Setting Range                   | Initial Value | Lock |
|----------------|-------------------------|---------------------------------|---------------|------|
| STEP001 to 400 |                         |                                 |               |      |
| SV *           | Step SV                 | Within SV limiter setting range | 0 digit       | 3    |
| Time           | Step time               | 00:00 to 99:59                  | 00:01         | 1    |
| PID            | Step PID No.            | 0 to 10                         | 0             | 1    |

## 18-4 PID Screen Group (group 3)

| Symbol               | Description of Function                          | Setting Range   | Initial Value                      | Lock |
|----------------------|--|---|------------------------------------|------|
| PID (01 to 10) -OUT1 |  |   |                                    |      |
| P                    | No.1 proportional band (OUT1)                    | OFF, 0.1 to 999.9 %   | 3.0 %                              | 1    |
| I                    | No.1 integral time (OUT1)                        | OFF, 1 to 6000 s  | 120 s                              | 1    |
| D                    | No.1 differential time (OUT1)                    | OFF, 1 to 3600 s  | 30 s                               | 1    |
| DF *                 | No.1 hysteresis (OUT1)                           | 1 to 9999 digit   | 20 digit                           | 1    |
| MR                   | No.1 manual reset (OUT1)                         | -50.0 to 50.0 %   | 0.0 %<br>-50.0 %<br>(1-loop,2-out) | 1    |
| SF                   | No.1 set value function (OUT1)                   | 0.00 to 1.00  | 0.40                               | 1    |
| ZN *                 | No.1 PID zone (CH1)                              | Within measuring range  | 0 digit                            | 1    |
| PID (01 to 10) -OUT2 |  |   |                                    |      |
| P                    | No.1 proportional band (OUT2)<br>(CH2)           | OFF, 0.1 to 999.9 %   | 3.0 %                              | 1    |
| I                    | No.1 integral time (OUT2) (CH2)                  | OFF, 1 to 6000 s  | 120 s                              | 1    |
| D                    | No.1 differential time (OUT2) (CH2)              | OFF, 1 to 3600 s  | 30 s                               | 1    |
| DF *                 | No.1 hysteresis (OUT2) (CH2)                     | 1 to 9999 digit   | 20 digit                           | 1    |
| DB *                 | No.1 dead band (OUT2)                            | -19999 to 20000 digit   | 0 digit                            | 1    |
| MR                   | No.1 manual reset (CH2)                          | -50.0 to 50.0 %   | 0.0 %                              | 1    |
| SF                   | No.1 target value function (OUT2)<br>(CH2)       | 0.00 to 1.00  | 0.40                               | 1    |
| ZN *                 | No.1 PID zone (CH2)                              | Within measuring range  | 0 digit                            | 1    |
| PID01-10<br>OUT1L    | No.1 output limiter lower limit value<br>(OUT1)  | 0.0 to 100.0 %  | 0.0 %                              | 1    |
| OUT1H                | No.1 output limiter higher limit value<br>(OUT1) | 0.0 to 100.0 %  | 100.0 %                            | 1    |
| OUT2L                | No.1 output limiter lower limit value<br>(OUT2)  | 0.0 to 100.0 %  | 0.0 %                              | 1    |
| OUT2H                | No.1 output limiter higher limit value<br>(OUT2) | 0.0 to 100.0 %  | 100.0 %                            | 1    |
| Zone<br>PID1         | Zone 1 PID mode                                  | OFF: No switching<br>PV: PV zone switching<br>SV: SV zone switching | OFF                                | 1    |
| HYS1 *               | Zone 1 hysteresis                                | 0 to 10000 digit  | 20 digit                           | 1    |
| PID2                 | Zone 2 PID mode (CH2)                            | OFF: No switching<br>PV: PV zone switching<br>SV: SV zone switching | OFF                                | 1    |
| HYS2 *               | Zone 2 hysteresis (CH2)                          | 0 to 10000 digit  | 20 digit                           | 1    |
| AT Point *           | Auto tuning point                                | 0 to 10000 digit  | 0                                  | 1    |

## 18-5 EVENT/DO Screen Group (group 4)

| Symbol                 | Description of Function                         | Setting Range  | Initial Value   | Lock |
|------------------------|---|--|---|------|
| EV1 to EV3, DO1 to DO9 |   |  |   |      |
| MD                     | EV1 to 3<br>DO1 to 9<br>Operation mode          | None : No action<br>DEV Hi : Higher limit deviation<br>DEV Low : Lower limit deviation<br>DEV Out : Outside higher/lower limit deviation<br>DEV In : Inside higher/lower limit deviation<br>PV Hi : PV higher limit absolute value<br>PV Low : PV lower limit absolute value<br>SO : Scale over<br>FIX : In FIX mode<br>AT : Auto tuning execution in progress<br>MAN : Manual output<br>LOGIC : Logic operation (*1 *2)<br>Direct : Direct output (*3)<br>RUN : RUN<br>HLD : Program hold<br>GUA : Guarantee soak zone<br>STEP : Step signal<br>PRG.END : Program end signal<br>TS1 : Time signal 1<br>TS2 : Time signal 2<br>TS3 : Time signal 3<br>TS4 : Time signal 4<br>TS5 : Time signal 5<br>TS6 : Time signal 6<br>TS7 : Time signal 7<br>TS8 : Time signal 8<br>HBA : Heater Break Alarm output (*4)<br>HLA : Heater Loop Alarm output (*4) | EV1: DEV Hi<br>EV2: DEV Low<br>EV3: RUN<br><br>DO1 to 9: None | 1    |
| ACT                    | EV1 to EV3<br>DO1 to DO9 output characteristics | N.O.: Normally open<br>N.C.: Normally closed   | N.O.  | 1    |
| DF *                   | EV1 to EV3<br>DO1 to DO9 hysteresis             | 1 to 9999 digit  | 20 digit  | 1    |
| IH                     | EV1 to EV3<br>DO1 to DO9 standby action         | OFF, 1/2/3   | OFF   | 1    |
| DLY                    | EV1 to EV3<br>DO1 to DO9 delay time             | OFF, 1 to 9999 s   | OFF   | 1    |

| Symbol                     | Description of Function         | Setting Range                                    | Initial Value | Lock |
|----------------------------|---------------------------------|--|---------------|------|
| EV1 to EV3 / DO1 to DO3    |                                 |  |               |      |
| SRC1<br>SRC2               | Source input1<br>Source input 2 | None/TS1 to TS8/TS1-C2 to TS8-C2/<br>DI1 to DI10 | None          | 1    |
| Gate1<br>Gate2             | Gate input1<br>Gate input 2     | BUF/INV/FF                                       | BUF           | 1    |
| Log MD                     | Logic operation mode            | AND/OR/XOR                                       | AND           | 1    |
| DO4, DO5 (when MD = LOGIC) |                                 |  |               |      |
| SRC                        | Source input                    | None/TS1 to TS8/TS1-C2 to TS8-C2/<br>DI1 to DI10 | None          | 1    |
| Log MD                     | Logic operation mode            | Timer / Counter                                  | Timer         | 1    |
| Time                       | Timer                           | OFF, 1 to 5000 s                                 | OFF           | 1    |
| Count                      | Counter                         | OFF, 1 to 5000                                   | OFF           | 1    |

\*1 Logic operation (AND, OR, XOR) can be assigned only to LOGIC EV1 to EV3, and DO1 to DO3.

\*2 Logic operation (Timer, Count) can be assigned only to DO4 and DO5.

\*3 Direct output can be assigned only to DO6 to DO9 with communication interface.

\*4 This function is optional and is not displayed when it is not installed.



**18-6 DI/Option Screen Group (group 5)**

| Symbol                                  | Description of Function   | Setting Range   | Initial Value | Lock |
|---|---|---|---------------|------|
| ---                                     | DI assignment channel<br>(in 2-loop)  | CH1/CH2/CH1+2   | CH1           | 1    |
| DI1                                     | DI1 assignment  | RUN/RST (fixed)   | --            | 1    |
| DI2                                     | DI2 assignment  | None<br>RUN/RST<br>RST<br>HLD<br>ADV<br>FIX<br>MAN<br>LOGIC   | None          | 1    |
| DI3<br>DI4<br>DI6<br>DI7<br>DI9<br>DI10 | DI3 assignment<br>DI4 assignment<br>DI6 assignment<br>DI7 assignment<br>DI9 assignment<br>DI10 assignment | None<br>RUN/RST<br>RST<br>HLD<br>ADV<br>FIX<br>MAN<br>LOGIC   | None          | 1    |
| DI5                                     | DI5 assignment  | None<br>RUN/RST<br>RST<br>HLD<br>ADV<br>FIX<br>MAN<br>LOGIC<br>PTN2bit<br>PTN3bit<br>PTN4bit<br>PTN5bit | None          | 1    |
| DI8                                     | DI8 assignment  | None<br>RUN/RST<br>RST<br>HLD<br>ADV<br>FIX<br>MAN<br>LOGIC<br>PTN2bit<br>PTN3bit                       | None          | 1    |

| Symbol  | Description of Function                   | Setting Range  | Initial Value                    | Lock |
|---------|---|--|----------------------------------|------|
| Ao1MD   | Analog output 1 type                      | PV : CH1 Measurement value<br>SV : CH1 Setting value<br>DEV : CH1 Deviation value<br>OUT1 : Output 1<br>CH2_PV : CH2 Measurement value<br>CH2_SV : CH2 Measurement value<br>CH2_DEV : CH2 Measurement value<br>OUT2 : Output 2 | PV                               | 1    |
| Ao1_L * | Analog output 1 lower limit side scaling  | PV, SV, CH2_PV, CH2_SV:<br>Within measuring range<br>DEV, CH2_DEV2 : -100.0 to 100.0 %<br>OUT1, OUT2 : 0.0 to 100.0 %  | Setting range lower limit value  | 1    |
| Ao1_H * | Analog output 1 higher limit side scaling | PV, SV, CH2_PV, CH2_SV:<br>Within measuring range<br>DEV, CH2_DEV2 : -100.0 to 100.0 %<br>OUT1, OUT2 : 0.0 to 100.0 %  | Setting range higher limit value | 1    |
| Ao2MD   | Analog output 2 type                      | PV : CH1 Measurement value<br>SV : CH1 Setting value<br>DEV : CH1 Deviation value<br>OUT1 : Output 1<br>CH2_PV : CH2 Measurement value<br>CH2_SV : CH2 Measurement value<br>CH2_DEV : CH2 Measurement value<br>OUT2 : Output 2 | SV                               | 1    |
| Ao2_L * | Analog output 2 lower limit side scaling  | PV, SV, CH2_PV, CH2_SV:<br>Within measuring range<br>DEV, CH2_DEV2 : -100.0 to 100.0 %<br>OUT1, OUT2 : 0.0 to 100.0 %  | Setting range lower limit value  | 1    |
| Ao2_H * | Analog output 2 higher limit side scaling | PV, SV, CH2_PV, CH2_SV:<br>Within measuring range<br>DEV, CH2_DEV2 : -100.0 to 100.0 %<br>OUT1, OUT2 : 0.0 to 100.0 %  | Setting range higher limit value | 1    |
| Heater  | Heater current value monitor              | 0.0 to 50.0A   | ---                              | ---  |
| HBA     | Heater Break alarm                        | OFF, 0.1 to 50.0 A   | OFF                              | 1    |
| HLA     | Heater loop alarm                         | OFF, 0.1 to 50.0 A   | OFF                              | 1    |
| HBM     | Heater Break mode                         | Lock: Lock<br>Real: Real   | Lock                             | 1    |
| HB      | Heater current detection selection        | OUT1: Control Output 1<br>OUT2: Control Output 2<br><br>(*1)   | OUT1                             | 1    |

\*1 HB can be selected when another choice besides 1-output is specified, and the output1/output2 is any combination from Y/Y, P/P, Y/P or P/Y.

| Symbol      | Description of Function    | Setting Range   | Initial Value | Lock |
|-------------|----------------------------|---|---------------|------|
| COM<br>PROT | Communication protocol     | SHIMADEN, MOD_ASC,<br>MOD_RTU   | SHIMADEN      | 1    |
| ADDR        | Communication address      | 1 to 98   | 1             | 1    |
| BPS         | Communication speed        | 2400 bps<br>4800 bps<br>9600 bps<br>19200 bps   | 9600 bps      | 1    |
| MEM         | Communication memory mode  | EEP : Write to EEPROM, RAM<br>RAM : Write to RAM only<br>R_E : Write to EEPROM other than SV, COM mode, out | EEP           | 1    |
| DATA        | Communication data length  | 7: 7 bit<br>8: 8 bit  | 7             | 1    |
| PARI        | Communication data parity  | EVEN/ODD/None   | EVEN          | 1    |
| STOP        | Communication stop bit     | 1/2   | 1             | 1    |
| DELY        | Communication delay time   | 1 to 50 ms  | 10 ms         | 1    |
| CTRL*1      | Communication control code | STX_ETX_CR<br>STX_ETX_CRLF<br>@:_:_CR   | STX_ETX_CR    | 1    |
| BCC *1      | Communication BCC check    | ADD<br>ADD_two's cmp<br>XOR<br>None   | ADD           | 1    |

\*1 SHIMADEN protocol only

- DI5 to DI10 and Ao1MD to BCC are optional and are not displayed when they are not installed.

### 18-7 Control Output Screen Group (group 6)

| Symbol       | Description of Function               | Setting Range  | Initial Value                       | Lock |
|--------------|---------------------------------------|--|-------------------------------------|------|
| OUT1 ACT     | Output 1 control characteristics      | Reverse: Reverse characteristics<br>Direct: Direct characteristics | Reverse                             | 1    |
| RST          | Output preset value at output 1 reset | 0.0 to 100.0 %   | 0.0 %                               | 1    |
| ERR          | Output preset value at output 1 error | 0.0 to 100.0 %   | 0.0 %                               | 1    |
| CYC          | Output 1 proportional cycle time      | 1 to 120 s   | Contact (Y) : 30 s<br>SSR (P) : 3 s | 1    |
| OUT2 ACT *1  | Output 2 control characteristics      | Reverse: Reverse characteristics<br>Direct: Direct characteristics | Direct (1-loop)<br>Reverse (2-loop) | 1    |
| RST *1       | Output preset value at output 2 reset | 0.0 to 100.0 %   | 0.0 %                               | 1    |
| ERR *1       | Output preset value at output 2 error | 0.0 to 100.0 %   | 0.0 %                               | 1    |
| CYC *1       | Output 2 proportional cycle time      | 1 to 120 s   | Contact (Y) : 30 s<br>SSR (P) : 3 s | 1    |
| Rate Limiter |                                       |  |                                     |      |
| Out1         | Output 1 rate-of-change limiter       | OFF, 0.1 to 100.0 %/s  | OFF                                 | 1    |
| Out2 *1      | Output 2 rate-of-change limiter       | OFF, 0.1 to 100.0 %/s  | OFF                                 | 1    |

\*1 Control output 2 is optional and is not displayed when it is not installed.

## 18-8 Unit/Range Screen Group (group 7)

| Symbol           | Description of Function      | Setting Range   | Initial Value            | Lock |
|------------------|------------------------------|---|--------------------------|------|
| 2-IN(func)       |                              |   |                          |      |
| PV_MODE          | PV1/PV2 Input mode           | MAX : Max. value in 2-input<br>MIN : Min. value in 2-input<br>AVE : Average value in 2-input<br>DEV : Deviation value in 2-input<br>PV : Input 1 PV | DEV                      | 1    |
| SO_MODE          | Scale over mode              | 0/1   | 0                        | 1    |
| PV Bias *        | PV bias                      | -10000 to 10000 digit   | 0 digit                  | 1    |
| PV Filter        | PV filter                    | OFF, 1 to 100 Sec   | OFF                      | 1    |
| PV Slope *<br>*1 | PV slope                     | 0.500 to 1.500 digit  | 1.000                    | 1    |
| INPUT1           |                              |   |                          |      |
| PV Bias *        | PV bias                      | -10000~10000 digit  | 0 digit                  | 1    |
| PV Filter        | PV filter                    | OFF, 1~100 Sec  | OFF                      | 1    |
| PV Slope *<br>*1 | PV slope                     | 0.500~1.500 digit   | 1.000                    | 1    |
| INPUT2           |                              |   |                          |      |
| PV Bias *        | PV bias                      | -10000~10000 digit  | 0 digit                  | 1    |
| PV Filter        | PV filter                    | OFF, 1~100 Sec  | OFF                      | 1    |
| PV Slope *<br>*1 | PV slope                     | 0.500~1.500 digit   | 1.000                    | 1    |
| RANGE            | Measuring range              | 01 to 19: Thermocouple<br>31 to 58: RTD<br>71 to 77: Voltage (mV)<br>81 to 87: Voltage (V)  | 06                       | 1    |
| Sc_L *           | PV lower limit side scaling  | -19999 to 29990 digit   | 0 digit                  | 1    |
| Sc_H *           | PV higher limit side scaling | -19989 to 30000 digit   | 1000 digit               | 1    |
| UNIT *           | Measurement unit             | RTD, TC : °C, °F<br>I, V : %, °C, °F, None  | RTD, TC : °C<br>I, V : % | 1    |
| DP *             | Decimal point position       | XXXXX. XXXX.X XXX.XX<br>XX.XXX X.XXXX   | XXXX.X                   | 1    |

|               |    |  |  |          |   |
|---------------|----|--|--|----------|---|
| Figure<br>*2  | *  | Number of digits past<br>decimal point     | Normal : Digits past decimal point<br>Short : No digits past decimal point | Normal   | 1 |
| CJ            | *3 | Cold junction<br>compensation              | Internal : Internal compensation<br>External : External compensation       | Internal | 1 |
| SQ.Root<br>*4 | *  | Square root extraction                     | OFF : No operation<br>ON : Operation                                       | OFF      | 1 |
| Low cut       | *4 | Low cut (Voltage input)                    | 0.0 to 5.0 %   | 1.0 %    | 1 |
| PMD           | *5 | Linearizer approximation                   | OFF : Approximation OFF<br>ON : Approximation ON                           | OFF      | 1 |
| A1 to A11     | *5 | Linearizer approximation<br>input 1 to 11  | -5.00 to 105.00 %  | 0.00 %   | 1 |
| B1 to B11     | *5 | Linearizer approximation<br>output 1 to 11 | -5.00 to 105.00 %  | 0.00 %   | 1 |

\*1 This screen is not displayed in the case of RTD and TC input.

\*2 This screen is not displayed in the case of voltage and current input.

\*3 This screen is displayed only in the case of TC input.

\*4 This screen is displayed only in the case of "square root function = ON".

\*5 This screen is displayed only in the case of RTD and TC input.

**18-9 Lock, etc. Screen Group (group 8)**

| Symbol       | Description of Function              | Setting Range  | Initial Value                         | Lock |
|--------------|--------------------------------------|--|---------------------------------------|------|
| KLOCK        | Key lock                             | OFF : Release<br>LOCK1 : Other than SV,<br>CONTROL<br>LOCK2 : Other than SV<br>LOCK3 : All | OFF                                   | ---  |
| OUTPUT       | Output mode                          | Single : 1-output<br>Dual : 2-output   | 1-output: Single<br>2-output: Dual    | 1    |
| IR COM       | Front panel communication            | ON : Enabled<br>OFF : Disabled   | ON                                    | 1    |
| SV Limit_L * | SV limiter lower limit value         | Within measuring range.<br>Note that L<H   | Measuring range<br>lower limit value  | 1    |
| SV Limit_H * | SV limiter higher limit value        | Within measuring range.<br>Note that L<H   | Measuring range<br>higher limit value | 1    |
| Time Unit    | Time unit                            | H/M: Hours/minutes<br>M/S: Minutes/second  | H/M                                   | 1    |
| PRG.Wait     | Program control execution delay time | 00h00m to 99h59m   | 00h00m                                | 1    |
| SO Mode      | Input error mode                     | HOLD : Hold state<br>RUN : RUN continued<br>RESET : Reset state                            | HOLD                                  | 1    |
| POWER ON     | Power interruption compensation      | RESET<br>CONTINUE  | RESET                                 | 1    |
| ADV Mode     | Advance mode                         | Step : Step<br>Time : Time   | Step                                  | 1    |
| ADV Time     | Advance time                         | 00:00 to 99:59   | 00:00                                 | 1    |
| CH1 PTN      | CH1 assigned pattern number          | 0 to 20  | 10                                    | 1    |

This page left intentionally blank.



## 19 PARAMETER SETUP RECORD SHEETS

Lots of parameters are set on this device before use.

Users will find these sheets will come in handy to restore a system in the event of a malfunction, for example, if they keep a detailed record of the product model No. they are using and the values set on this device.

We recommend that you fully utilize these record sheets by making a blank copy of these tables and entering the required values on the copied record sheet.

### 19-1 Product Model Code

|       |    |   |    |    |   |   |   |   |   |
|-------|----|---|----|----|---|---|---|---|---|
| FP23- | D□ | □ | □- | □□ | □ | □ | □ | □ | □ |
|       |    |   |    |    |   |   |   |   |   |

### 19-2 CTRL EXEC Parameters

| Item          | CH1 | CH2 |
|---------------|-----|-----|
| AT            |     |     |
| MAN           |     |     |
| HLD           |     |     |
| ADV           |     |     |
| Start PTN     |     |     |
| PTN Link Reps |     |     |
| Link Format   |     |     |
| 1st           |     |     |
| 2nd           |     |     |
| 3rd           |     |     |
| 4th           |     |     |
| 5th           |     |     |
| 6th           |     |     |
| 7th           |     |     |
| 8th           |     |     |
| 9th           |     |     |
| 10th          |     |     |
| 11th          |     |     |
| 12th          |     |     |
| 13th          |     |     |
| 14th          |     |     |
| 15th          |     |     |
| 16th          |     |     |
| 17th          |     |     |
| 18th          |     |     |
| 19th          |     |     |
| 20th          |     |     |

| Item              | CH1 | CH2 |
|-------------------|-----|-----|
| FIX MODE          |     |     |
| FIX SV            |     |     |
| FIX PID           |     |     |
| FIX MOVE          |     |     |
| FIX EV1 Set Point |     |     |
| FIX EV2 Set Point |     |     |
| FIX EV3 Set Point |     |     |
| FIX DO1 Set Point |     |     |
| FIX DO2 Set Point |     |     |
| FIX DO3 Set Point |     |     |
| FIX DO4 Set Point |     |     |
| FIX DO5 Set Point |     |     |
| FIX DO6 Set Point |     |     |
| FIX DO7 Set Point |     |     |
| FIX DO8 Set Point |     |     |
| FIX DO9 Set Point |     |     |

### 19-3 PROG STEP Parameters

PTN No. \_\_\_\_\_

| Item           | CH1 | CH2 |
|----------------|-----|-----|
| Num. of STEP   |     |     |
| Start STEP     |     |     |
| Start SV       |     |     |
| PTN Repts      |     |     |
| Loop setup     |     |     |
| Start          |     |     |
| End            |     |     |
| Reps           |     |     |
| GUARantee Soak |     |     |
| Zone           |     |     |
| Time           |     |     |
| PV Start       |     |     |

| Item          | CH1 | CH2 |
|---------------|-----|-----|
| EV1 Set Point |     |     |
| EV2 Set Point |     |     |
| EV3 Set Point |     |     |
| DO1 Set Point |     |     |
| DO2 Set Point |     |     |
| DO3 Set Point |     |     |
| DO4 Set Point |     |     |
| DO5 Set Point |     |     |
| DO6 Set Point |     |     |
| DO7 Set Point |     |     |
| DO8 Set Point |     |     |
| DO9 Set Point |     |     |

STEP No. \_\_\_\_\_

| Item | CH1 | CH2 |
|------|-----|-----|
| SV   |     |     |
| Time |     |     |
| PID  |     |     |

STEP No. \_\_\_\_\_

| Item | CH1 | CH2 |
|------|-----|-----|
| SV   |     |     |
| Time |     |     |
| PID  |     |     |

STEP No. \_\_\_\_\_

| Item | CH1 | CH2 |
|------|-----|-----|
| SV   |     |     |
| Time |     |     |
| PID  |     |     |

STEP No. \_\_\_\_\_

| Item | CH1 | CH2 |
|------|-----|-----|
| SV   |     |     |
| Time |     |     |
| PID  |     |     |

STEP No. \_\_\_\_\_

| Item | CH1 | CH2 |
|------|-----|-----|
| SV   |     |     |
| Time |     |     |
| PID  |     |     |

STEP No. \_\_\_\_\_

| Item | CH1 | CH2 |
|------|-----|-----|
| SV   |     |     |
| Time |     |     |
| PID  |     |     |

STEP No. \_\_\_\_\_

| Item | CH1 | CH2 |
|------|-----|-----|
| SV   |     |     |
| Time |     |     |
| PID  |     |     |

STEP No. \_\_\_\_\_

| Item | CH1 | CH2 |
|------|-----|-----|
| SV   |     |     |
| Time |     |     |
| PID  |     |     |

STEP No. \_\_\_\_\_

| Item | CH1 | CH2 |
|------|-----|-----|
| SV   |     |     |
| Time |     |     |
| PID  |     |     |

STEP No. \_\_\_\_\_

| Item | CH1 | CH2 |
|------|-----|-----|
| SV   |     |     |
| Time |     |     |
| PID  |     |     |

PTN No. \_\_\_\_\_

| Item           | CH1 | CH2 |
|----------------|-----|-----|
| Num. of STEP   |     |     |
| Start STEP     |     |     |
| Start SV       |     |     |
| PTN Reps       |     |     |
| Loop setup     |     |     |
| Start          |     |     |
| End            |     |     |
| Reps           |     |     |
| GUArantee Soak |     |     |
| Zone           |     |     |
| Time           |     |     |
| PV Start       |     |     |

| Item          | CH1 | CH2 |
|---------------|-----|-----|
| EV1 Set Point |     |     |
| EV2 Set Point |     |     |
| EV3 Set Point |     |     |
| DO1 Set Point |     |     |
| DO2 Set Point |     |     |
| DO3 Set Point |     |     |
| DO4 Set Point |     |     |
| DO5 Set Point |     |     |
| DO6 Set Point |     |     |
| DO7 Set Point |     |     |
| DO8 Set Point |     |     |
| DO9 Set Point |     |     |

STEP No. \_\_\_\_\_

| Item | CH1 | CH2 |
|------|-----|-----|
| SV   |     |     |
| Time |     |     |
| PID  |     |     |

STEP No. \_\_\_\_\_

| Item | CH1 | CH2 |
|------|-----|-----|
| SV   |     |     |
| Time |     |     |
| PID  |     |     |

STEP No. \_\_\_\_\_

| Item | CH1 | CH2 |
|------|-----|-----|
| SV   |     |     |
| Time |     |     |
| PID  |     |     |

STEP No. \_\_\_\_\_

| Item | CH1 | CH2 |
|------|-----|-----|
| SV   |     |     |
| Time |     |     |
| PID  |     |     |

STEP No. \_\_\_\_\_

| Item | CH1 | CH2 |
|------|-----|-----|
| SV   |     |     |
| Time |     |     |
| PID  |     |     |

STEP No. \_\_\_\_\_

| Item | CH1 | CH2 |
|------|-----|-----|
| SV   |     |     |
| Time |     |     |
| PID  |     |     |

STEP No. \_\_\_\_\_

| Item | CH1 | CH2 |
|------|-----|-----|
| SV   |     |     |
| Time |     |     |
| PID  |     |     |

STEP No. \_\_\_\_\_

| Item | CH1 | CH2 |
|------|-----|-----|
| SV   |     |     |
| Time |     |     |
| PID  |     |     |

STEP No. \_\_\_\_\_

| Item | CH1 | CH2 |
|------|-----|-----|
| SV   |     |     |
| Time |     |     |
| PID  |     |     |

STEP No. \_\_\_\_\_

| Item | CH1 | CH2 |
|------|-----|-----|
| SV   |     |     |
| Time |     |     |
| PID  |     |     |

**19-4 PID Parameters**

**OUT1 (CH1)**

| PID No. | P | I | D | DF | MR | SF | ZN | OUT1L | OUT1H |
|---------|---|---|---|----|----|----|----|-------|-------|
| 01      |   |   |   |    |    |    |    |       |       |
| 02      |   |   |   |    |    |    |    |       |       |
| 03      |   |   |   |    |    |    |    |       |       |
| 04      |   |   |   |    |    |    |    |       |       |
| 05      |   |   |   |    |    |    |    |       |       |
| 06      |   |   |   |    |    |    |    |       |       |
| 07      |   |   |   |    |    |    |    |       |       |
| 08      |   |   |   |    |    |    |    |       |       |
| 09      |   |   |   |    |    |    |    |       |       |
| 10      |   |   |   |    |    |    |    |       |       |

**OUT2 (CH2)**

| PID No. | P | I | D | DF | MR/DB | SF | ZN | OUT1L | OUT1H |
|---------|---|---|---|----|-------|----|----|-------|-------|
| 01      |   |   |   |    |       |    |    |       |       |
| 02      |   |   |   |    |       |    |    |       |       |
| 03      |   |   |   |    |       |    |    |       |       |
| 04      |   |   |   |    |       |    |    |       |       |
| 05      |   |   |   |    |       |    |    |       |       |
| 06      |   |   |   |    |       |    |    |       |       |
| 07      |   |   |   |    |       |    |    |       |       |
| 08      |   |   |   |    |       |    |    |       |       |
| 09      |   |   |   |    |       |    |    |       |       |
| 10      |   |   |   |    |       |    |    |       |       |

**Zone PID**

| Item      | Set Value |
|-----------|-----------|
| Zone PID1 |           |
| Zone HYS1 |           |
| Zone PID2 |           |
| Zone HYS2 |           |
| AT Point  |           |

**19-5 EVENT/DO Parameters**

| Item   | EV1 | EV2 | EV3 | DO1 | DO2 | DO3 |
|--------|-----|-----|-----|-----|-----|-----|
| CH     |     |     |     |     |     |     |
| MD     |     |     |     |     |     |     |
| ACT    |     |     |     |     |     |     |
| DF     |     |     |     |     |     |     |
| IH     |     |     |     |     |     |     |
| DLY    |     |     |     |     |     |     |
| Log MD |     |     |     |     |     |     |
| SRC1   |     |     |     |     |     |     |
| GATE1  |     |     |     |     |     |     |
| SRC2   |     |     |     |     |     |     |
| GATE2  |     |     |     |     |     |     |

| Item        | DO4 | DO5 | DO6 | DO7 | DO8 | DO9 |
|-------------|-----|-----|-----|-----|-----|-----|
| CH          |     |     |     |     |     |     |
| MD          |     |     |     |     |     |     |
| ACT         |     |     |     |     |     |     |
| DF          |     |     |     |     |     |     |
| IH          |     |     |     |     |     |     |
| DLY         |     |     |     |     |     |     |
| Log MD      |     |     |     | --- | --- | --- |
| SRC         |     |     | --- | --- | --- | --- |
| Time /Count |     |     | --- | --- | --- | --- |

**19-6 DI/Options Parameters**

| Item  | Set Value | CH set |
|-------|-----------|--------|
| DI1   |           |        |
| DI2   |           |        |
| DI3   |           |        |
| DI4   |           |        |
| DI5   |           |        |
| DI6   |           |        |
| DI7   |           |        |
| DI8   |           |        |
| DI9   |           |        |
| DI10  |           |        |
| Ao1MD |           | ---    |
| Ao1 L |           | ---    |
| Ao1 H |           | ---    |
| Ao2MD |           | ---    |
| Ao2 L |           | ---    |
| Ao2 H |           | ---    |

| Item     | Set Value |
|----------|-----------|
| HBA      |           |
| HLA      |           |
| HBM      |           |
| HB       |           |
| COM PROT |           |
| ADDR     |           |
| BPS      |           |
| MEM      |           |
| DATA     |           |
| PARI     |           |
| STOP     |           |
| DELY     |           |
| CTRL     |           |
| BCC      |           |

**19-7 Control Output Parameters**

| Item         | OUT1 | OUT2 |
|--------------|------|------|
| ACT          |      |      |
| RST          |      |      |
| ERR          |      |      |
| CYC          |      |      |
| Rate Limiter |      |      |

**19-8 Unit/Measuring Range Parameters**

2-input related

| Item           |         | Set Value |
|----------------|---------|-----------|
| 2-IN<br>(FUNC) | PV_MODE |           |
|                | SO_MODE |           |

| Item   |           | Set Value |
|--------|-----------|-----------|
| INPUT1 | PV Bias   |           |
|        | PV Filter |           |
|        | PV Slope  |           |
| INPUT2 | PV Bias   |           |
|        | PV Filter |           |
|        | PV Slope  |           |

**Input setting**

| Item      | CH1 | CH2 |
|-----------|-----|-----|
| PV Bias   |     |     |
| PV Filter |     |     |
| PV Slope  |     |     |
| RANGE     |     |     |
| Sc_L      |     |     |
| Sc_H      |     |     |
| UNIT      |     |     |
| DP        |     |     |
| Figure    |     |     |
| CJ        |     |     |
| SQ. Root  |     |     |
| Low Cut   |     |     |
| PMD       |     |     |

**Input point set values**

| Input point No. | CH1 |    | CH2 |    |
|-----------------|-----|----|-----|----|
|                 | An  | Bn | An  | Bn |
| 1               |     |    |     |    |
| 2               |     |    |     |    |
| 3               |     |    |     |    |
| 4               |     |    |     |    |
| 5               |     |    |     |    |
| 6               |     |    |     |    |
| 7               |     |    |     |    |
| 8               |     |    |     |    |
| 9               |     |    |     |    |
| 10              |     |    |     |    |
| 11              |     |    |     |    |

**19-9 Lock, etc. Parameters**

| Item   | Set value |
|--------|-----------|
| KLOCK  |           |
| OUTPUT |           |
| IR COM |           |

| Item       | CH1 set value | CH2 set value |
|------------|---------------|---------------|
| SV Limit_L |               |               |
| SV Limit_H |               |               |
| Time Unit  |               |               |
| PRG.Wait   |               |               |
| SO Mode    |               |               |
| POWER ON   |               |               |
| ADV Mode   |               |               |
| ADV Time   |               |               |



## 20 SPECIFICATIONS

### 20-1 Display

- ◆ LED display Measured value (PV): 7-segment red LED 5 digits, height of characters 16 mm  
Set value (SV) : 7-segment green LED 5 digits, height of characters 11 mm
- ◆ LCD display PTN No., STP No., Graph Pattern, control output value, various parameter displays  
128 x 32 dot matrix liquid crystal display with yellow-green LED backlight
- ◆ Action display lamps 17 action statuses display. Lights on or blinks depending on the status
 

|            |        |  |
|------------|--------|--|
| RUN        | Green  | Lights when control is executed, blinks when program execution is waiting                      |
| HLD        | Green  | Lights when program operation is stopped temporarily, blinks when it is stopped by input error |
| MAN        | Green  | Lights when manual control is in operation   |
| FIX        | Green  | Lights when FIX (fixed value control) mode   |
| EV1 to EV3 | Orange | Lights when event output is ON   |
| DO1 to DO5 | Orange | Lights when DO output is ON  |
| COM        | Green  | Lights when the communication mode is ON   |
| EXT        | Green  | Lights when start pattern external switching is assigned                                       |
| AT         | Green  | Lights when auto tuning is in standby, blinks when it is being executed                        |
| OUT1       | Green  | Control Output 1   |
| OUT2       | Green  | Control Output 2   |
| CH2        | Green  | Lights when CH2 PV and SV are displayed (in 2-loop)  |
| PV         | Green  | Lights when CH1 PV and CH2 SV (7-segment LED in LED display) are displayed (in 2-loop)         |
- ◆ Display accuracy  $\pm(0.1\% + 1\text{digit})$  of measuring range (See Measuring Range Code Table for individual ranges.)
 

|             |  |
|-------------|--|
| TC input    | $\pm(0.1\% \text{ FS} + 1^\circ\text{C})$  |
| Pt input    | $\pm(0.1\% \text{ FS} + 0.1^\circ\text{C})$  |
| mV, V input | $\pm(0.1\% \text{ FS} + 1 \text{ digit})$  |
| mA input    | Depends on accuracy of externally attached resistor<br>(When $\pm 0.1\% \text{ FS}$ accuracy is required, specify when ordering) |
- ◆ Temperature range for maintaining display accuracy  $23^\circ\text{C} \pm 5^\circ\text{C}$
- ◆ Display resolution 0.0001, 0.001, 0.01, 0.1, 1 (differs depending on measuring range)
- ◆ Sampling cycle 0.1 seconds (100 msec)

### 20-2 Setting

- ◆ Local setting By 10 front panel key switches
- ◆ SV setting range Same as measuring range (within setting limiter)
- ◆ Higher/lower setting limiter Any value in measuring range (lower limit value < higher limit value)

## 20-3 Input

- ◆ Universal-input, multi-range
  - Thermocouple input, RTD input, voltage input (mV, V), current input (mA)
- ◆ Thermocouple (TC)
  - Input type B, R, S, K, E, J, T, N, PLII, PR40-20, WRe5-26, {L, U (DIN43710)}, K, AuFe-Cr (Kelvin scale). For details, see Measuring Range Code Table.
  - Display range  $\pm 10\%$  of measuring range
  - Allowable range of external resistance 100 $\Omega$  max.
  - Input resistance Approx. 500 k $\Omega$
  - Cold junction compensation
    - Selectable between internal and external cold junction compensation
  - Internal cold junction compensation accuracy  $\pm 1^\circ\text{C}$  (in range of 18 to 28 $^\circ\text{C}$ )
  - Burnout functions Standard feature (up scale)
- ◆ RTD input type
  - JIS Pt100 /JPt100 3-wire type. For details, see Measuring Range Code Table.
  - Display range  $\pm 10\%$  of measuring range (not lower than -273.15 $^\circ\text{C}$ )
  - Lead wire tolerance 10 $\Omega$  max. per wire
  - Amperage Approx. 1.1mA
- ◆ Voltage input (mV, V) type
  - 10 to 10, 0 to 10, 0 to 20, 0 to 50, 10 to 50, 0 to 100, -100 to 100 mV
  - 1 to 1, 0 to 1, 0 to 2, 0 to 5, 1 to 5, 0 to 10, -10 to 10 V
  - Universal-input, programmable scaling
  - For details, see Measuring Range Code Table.
  - Input resistance Approx. 500 k $\Omega$
- ◆ Current input (mA) type
  - 4 to 20, 0 to 20 mA: universal-input and programmable scaling
  - For details, see Measuring Range Code Table.
  - Receiving resistance 250 $\Omega$  by external resistor
- ◆ Common functions
  - Sampling cycle 0.1 seconds (100 msec)
  - PV bias  $\pm 10000$  digit
  - PV slope Input value x 0.500 to 1.500
  - PV filter OFF, 1 to 100 seconds
- ◆ Input operation
  - Possible with voltage or current input
  - Square root extraction operation
    - Low cut range 0.0 to 5.0% FS
  - Linearizer approximation
    - Number of input points: 11
- ◆ Isolation
  - Insulated between input and DI input, or input and various outputs.
  - Not insulated between input and the system, or input and CT input.

## 20-4 Control

- ◆ Control output 1-output specification, 2-output specification  
In the case of independent 2-channel control (CH1, CH2) specification, control output 2 is the output on CH2 side.
- ◆ Control system (common to Control Output 1 and 2)
  - Expert PID control with auto tuning function
  - Multi-PID By PID Nos.01 to 10 (10 types)
  - Individual PID set on each step and FIX SV
  - Zone PID Selectable between individual PID and zone PID (max. 10 zones)
  - Proportional band (P) OFF, 0.1 to 999.9% (OFF: ON-OFF action)
  - Integral time (I) OFF, 1 to 6000 seconds (OFF: P or PD control)
  - Derivative time (D) OFF, 1 to 3600 seconds (OFF: P or PI control)
  - Manual reset (MR) -50.0 to 50.0% (available when I = OFF)
  - Dead band (DB) -19999 to 20000 digit (Control Output 2 in 1-loop/2-out specification)
  - Hysteresis (DF) 1 to 9999 digit (at ON-OFF action, available when P = OFF)
  - Proportional cycle 1 to 120 seconds (at contact or SSR drive voltage output)
- ◆ Control output type/rating (common to Control Outputs 1 and 2)
  - Y: Contact 1c, contact rating 240 V AC/2.5A resistive load, 1A inductive load
  - I: Current 4 to 20 mA DC/load resistance 600Ω max.
  - P: SSR drive voltage 12 V±1.5 V DC/load current 30 mA max.
  - V: Voltage 0 to 10 V DC/load current 2 mA max.
- Output accuracy ±0.5% FS (5 to 100% output/within accuracy maintaining temperature range)
- Resolution Approx. 1/14000 (during current or voltage output)
- ◆ Operation/output update cycle 0.1 seconds (100 msec)
- ◆ Control output characteristics Reverse (for heating)/Direct (for cooling), Control Outputs 1 and 2 set individually (heating/cooling, 2-stage heating/2-stage cooling selectable in 1-loop, 2-output specification)
- ◆ Higher/lower output limiter setting range Higher limit/lower limit (set individually for each PID No.)  
0.0 to 100.0% (lower limit < higher limit)
- ◆ Output rate-of-change OFF, 0.1 to 100.0%/seconds (set individually for control outputs limiter 1 and 2)
- ◆ Control output at error 0.0 to 100.0% (set individually for Control Outputs 1 and 2)
- ◆ Control output at standby 0.0 to 100.0% (set individually for Control Outputs 1 and 2)
- ◆ Manual control
  - Auto/manual switching Balanceless/bumpless action (simultaneous for Control Outputs 1 and 2)
  - Output setting range 0.0 to 100.0% set individually for Control Output 1 and 2
  - Setting resolution 0.1%
- ◆ Isolation Insulated between Control Output and the system.  
Not insulated between Control Outputs.

## 20-5 Program Function

- ◆ Number of patterns      Max. 20 patterns
- ◆ Number of steps        Max. 400 steps
- ◆ Step time                0 minutes 0 seconds to 99 minutes 59 seconds or 0 hours 0 minutes to 99 hours 59 minutes
- ◆ Pattern execution counts
  - Repeatable to 9999 times max.
- ◆ Step loop count        Repeatable to 9999 times max.
- ◆ Pattern link setting    Connectable to 20 patterns max.  
Executable to 9999 times max.
- ◆ Link execution setting   Repeatable to 9999 times max.
- ◆ Program settings        By front panel keys or communication
  - Level                    Same as measuring range
  - Time (1)                0 to 99 hours 59 minutes/step
  - Time (2)                0 to 99 minutes 59 seconds/step
  - Ramp settings         Automatic computation by setting time and level  
Ascend, descend, ramp control
  - Timer                    Sets the delay time for start of program operation  
00 hours 00 minutes to 99 hours 59 minutes
- ◆ Setting resolution
  - Level                    0.1 or 1 (varies according to measuring range)
  - Time                     1 minute or 1 second
- ◆ Advance function        Program moves to next step during operation.
- ◆ Hold function            Progress of program time is stopped temporarily during operation.
- ◆ Time signal setting
  - Number of registrations    Max. 8 points per pattern. (TS1~TS8) Assigned to event output or DO
  - Time (1)                0 to 99 hours 59 minutes
  - Time (2)                0 to 99 minutes 59 seconds
  - Resolution               1 minute or 1 second
- ◆ Guarantee soak zone    When the program moves from a ramp step to a flat step, the program does not move to the next step if the PV value is not in the set zone range or is not more than the preset time.
  - Setting resolution        0 to 9999 digit
  - Time (1)                0 to 99 hours 59 minutes
  - Time (2)                0 to 99 minutes 59 seconds

## 20-6 Event Output

- ◆ Number of outputs Total 3; EV1 to EV3
- ◆ Output rating 240 V AC/1.0A resistive load common to contact outputs (normally open contacts)
- ◆ Output update cycle 0.1 seconds (100 msec)
- ◆ Setting/selection Individual setting (individual output), selectable from the following 27 types (to designate output)  
In the case of independent 2-channel control (CH1, CH2) specification, assignment will be done to either CH1 or CH2.
- ◆ Output types
  - 1) None No action (no assignment)
  - 2) DEV Hi Higher limit deviation alarm
  - 3) DEV Low Lower limit deviation alarm
  - 4) DEV Out Outside higher/lower limit deviation alarm
  - 5) DEV In Inside higher/lower limit deviation alarm
  - 6) PV Hi PV higher limit alarm
  - 7) PV Low PV lower limit alarm
  - 8) SO ON at scale over
  - 9) FIX ON in FIX mode
  - 10) AT ON during execution of auto tuning
  - 11) MAN ON during manual control
  - 12) LOGIC ON during logic operation output
  - 13) RUN ON during control execution
  - 14) HLD ON during program hold
  - 15) GUA ON during guarantee soak
  - 16) STEP ON during step move
  - 17) PRG. END ON at program end
  - 18) TS1 ON during time signal 1
  - |
  - 25) TS8 ON during time signal 8
  - 26) Direct ON during direct output by communication
  - 27) HBA ON during Heater Break alarm action
  - 28) HLA ON during Heater Loop alarm action
- ◆ Setting range
  - DEV Hi, Low -25000 to 25000 digit
  - DEV Out, In 0 to 25000 digit
  - PV Hi, Low Within measuring range
  - Hysteresis 1 to 9999 digit (when DEV or PV is selected)
  - Action delay time OFF, 1 to 9999 digit (when DEV or PV is selected)
  - Standby action Selectable from 3 types (when DEV or PV is selected)
  - OFF No standby action
    - 1 At power ON, or at RST -> RUN
    - 2 At power ON, at RST -> RUN, or at execution SV is changed
    - 3 At input error (SO), when action is OFF
- Output character is-  
tics switching Selectable between normally open and normally closed
- ◆ Isolation Insulated between event output and various I/O, or event output and the system.

## 20-7 External Control Output (DO)

- ◆ Number of outputs 9 points in total; standard 5 and 4 optional
 

|            |                       |                     |
|------------|-----------------------|---------------------|
| DO1 to DO3 | Darlington output     | 3 points            |
| DO4 to DO5 | Open collector output | 2 points            |
| DO6 to DO9 | Open collector output | 4 points (optional) |
- ◆ Output rating Open collector output 24 V DC/8 mA max., ON voltage 0.8V max.  
Darlington output 24 V DC/50mA max., ON voltage 1.5V max.
- ◆ Output update cycle 0.1 seconds (100 msec)
- ◆ Setting/selection Individual setting (individual output), selectable.  
In the case of independent 2-channel control (CH1, CH2) specification, assignment will be done to either CH1 or CH2.  
Details are the same as those for event outputs.  
(However, LOGIC can be assigned to only DO1 to DO5. Direct can be assigned to only DO6 to DO9 with communication option.)  
Details of setting range, hysteresis, action delay time and stand by action are the same as those for event outputs.
- ◆ Output characteristics switching Normal open and normal close selectable
- ◆ Isolation Insulated between DO and various I/O, or DO and the system.  
Not insulated between DOs.

## 20-8 External Control Input (DI)

- ◆ Number of inputs 10 points in total; standard 4 and 6 optional
 

|             |                     |
|-------------|---------------------|
| DI1 to DI4  | 4 points            |
| DI5 to DI10 | 6 points (optional) |
- ◆ Input rating Non-voltage contact or open collector
 

|                      |   |
|----------------------|---|
| Input specifications |   |
| Photocoupler input   | 5 V DC, 2.5 mA max. Voltage application per 1 input |
| Input holding time   | 0.1 seconds (100 msec)                              |
- ◆ Setting/selection Individual setting (individual input), selectable from 12 types
 

|  |  |
|--|--|
| In the case of independent 2-channel control (CH1, CH2) specification, assignment will be done to either CH1 or CH2 or both. |  |
| 1) None  | No action (no assignment)  |
| 2) RUN/RST   | Switching of Run/Reset (when ON: Run execution)                          |
| 3) RST   | Forced Reset (when ON: Reset state)                                      |
| 4) HLD   | Control suspension/restart (when ON: suspension state)                   |
| 5) ADV   | Execute advance (when ON: execute advance)                               |
| 6) FIX   | Switching of FIX mode/Program mode (when ON: FIX mode)                   |
| 7) MAN   | Switching of control output between auto/manual (when ON: manual)        |
| 8) LOGIC   | Logic operation input [exclusive port] (when ON: input ON)               |
| 9) PTN2bit   | Selection of start pattern No. by DI input (selectable from 3 patterns)  |
| 10) PTN3bit  | Selection of start pattern No. by DI input (selectable from 7 patterns)  |
| 11) PTN4bit  | Selection of start pattern No. by DI input (selectable from 15 patterns) |
| 12) PTN5bit  | Selection of start pattern No. by DI input (selectable from 20 patterns) |
- ◆ Isolation Insulated between DI and various I/O, or DI and the system  
Not insulated between DIs.

## 20-9 Logic Operation Functions

- ◆ Number of logic Assignable to 8 points in total: EV1 to EV3 3 points, DO1 to DO5 5 points  
DO4 and DO5 are exclusively for timer and counter operation.
- ◆ Logic operation inputs In the case of independent 2-channel control (CH1, CH2) specification, TS1 to TS8 (CH1), TS1 to TS8 (CH2), and DI1 to DI10, can be assigned individually to source 1 and 2
- ◆ Input logic conversion Input logic conversion possible individually on source 1 and 2 (EV1 to EV3, DO1 to DO3 output)
  - 1) BUF By external control input logic
  - 2) INV Inversion of external control input logic
  - 3) FF Flip-flop logic operation of external control input  
(When a time signal is assigned to a source, flip-flop cannot be set.)
- ◆ Logic operation (1) Logic operation output by source 1 and 2 (EV1 to EV3, DO1 to DO3 output)
  - 1) AND Output by logical product
  - 2) OR Output by logical sum
  - 3) XOR Output by exclusive OR
- ◆ Logic operation (2) Logic operation Output by source 1 (DO4, DO5 output)
  - 1) Timer operation OFF, 1 to 5000 seconds
  - 2) Counter operation OFF, 1 to 5000 counts

## 20-10 2-input Specification

- ◆ **Input types** Input 1 and Input 2, individual selection, individual setting, universal input, multi range  
Thermocouple input, R.T.D. input, voltage input (mV, V), current input (mA)
- ◆ **Input and control specifications** Specifications to be decided by combinations of input and control output.
  - 1-loop control specification
    - 1) 2-input operation (PV1, PV2) and 1-output
      - MAX Max. value input of PV1 and PV2, 1-output/2-output control specification
      - MIN Min. value input of PV1 and PV2, 1-output/2-output control specification
      - AVE Average value input of PV1 and PV2, 1-output/2-output control specification
      - DEV Deviation value input of PV1 - PV2, 1-output/2-output control specification
      - PV Taking PV value of PV1
    - 2) 2-input operation (PV1, PV2) and 2-output
  - 2-loop control specification
    - 1) Independent 2-channel control specification
- ◆ **Isolation** Insulated between Input 2 and DI input, or input and various outputs  
Not insulated between Input 1 (standard input) and Input 2, input and the system, input and remote input, or input and CT input

## 20-11 Heater Break Alarm (option)

- ♦ Alarm action
  - HBA alarm ON when control output is ON and heater break is detected
  - HLA alarm ON when control output is OFF and heater loop error is detected
- Alarm detection
  - HBA is detected at heater current  $\leq$  setting current value, when control output is ON
  - HLA is detected at heater current  $\geq$  setting current value, when control output is OFF
  - Hysteresis at heater Break or loop error detection 0.2 A
- ♦ Current detection
  - Heater current detection by external CT (supplied CT for exclusive use/single phase)
  - Current detection selection
    - Selectable from Control Output 1 or Control Output 2 only when control output is Y or P
  - Sampling cycle
    - 0.2 seconds (200 msec)
  - Minimum action confirmation time
    - 0.2 seconds (200 msec) or longer (regardless of whether control output is ON or OFF)
- ♦ Current setting
  - Heater break, heater loop alarm set individually
  - Setting range
    - OFF, 0.1 to 50.0 A (OFF = suspension of alarm action)
  - Setting resolution
    - 0.1 A
- ♦ Current display
  - 0.0 to 55.0 A
  - Display accuracy
    - 3% FS (sine wave 50 Hz)
  - Sampling cycle
    - 0.2 seconds (200 msec)
  - Minimum action confirmation time
    - 0.2 seconds (200 msec) or longer (regardless of whether control output is ON or OFF)
- ♦ Output
  - Assigned to EVENT, DO output
  - Output hold
    - Selectable between Lock mode and Real mode
- ♦ Isolation
  - Insulated between CT input and DI input, or CT input and various outputs.
  - Not insulated between CT input and sensor input, or CT input and the system.

## 20-12 Analog Output (option)

- ♦ Number of Outputs
  - Maximum 2, A\_o1, A\_o2 individual setting, individual output
  - Only A\_o1 when sensor power supply (optional) is selected
  - In the case of independent 2-channel control (CH1, CH2) specification, assignment will be done to either CH1 or CH2.
- ♦ Output types
  - Selectable from 8 types
  - PV, SV, DEV, OUT1, CH2\_PV, CH2\_SV, CH2\_DEV, OUT2
  - Output rating
    - Individual selection (individual output)
    - 0 to 10 mV DC/output resistance 10 $\Omega$
    - 0 to 10 V DC/load current 2 mA max.
    - 4 to 20mA DC/load resistance 300 $\Omega$  max.
- ♦ Output accuracy
  - $\pm 0.1\%$  FS (of indicated value)
- ♦ Output resolution
  - Approx. 1/14000
- ♦ Output update cycle
  - 0.1 second (100 msec)
- ♦ Output scaling
  - PV, SV, CH2\_PV, CH2\_SV: within measuring range
  - DEV, CH2\_DEV: within -100.0 to 100.0%;
  - OUT1, OUT2 within 0.0 to 100.0%; reverse scaling possible
- ♦ Isolation
  - Insulated between analog outputs and various I/O or analog outputs and the system.
  - Not insulated between analog outputs (A\_o1 and A\_o2)



## 20-13 Sensor Power Supply (option)

- ◆ Number of outputs 1  
Output from Analog Output 2 (A\_o2) terminal  
When the sensor power supply (SPS) is selected, Analog Output 2 (A\_o2) is unusable.
- ◆ Output rating 24 V DC/25 mA max.
- ◆ Isolation Insulated between SPS and various I/O, SPS and analog output 1, or SPS and the system.

## 20-14 Communication (option)

- ◆ Communication type RS-232C, RS-485
- ◆ Communication system
  - RS-232C 3-line half-duplex system
  - RS-485 2-line half-duplex multidrop (bus) system
- ◆ Communication distance
  - RS-232C 15 m max.
  - RS-485 500 m max. (depending on connection conditions)
- ◆ Number of connectable devices
  - RS-232C 1
  - RS-485 32 (including the host, differs depending on connection conditions)
- ◆ Synchronization system Start-stop synchronization
- ◆ Communication speed 2400, 4800, 9600, 19200 bps
- ◆ Communication (device) address 1 to 98
- ◆ Communication delay time 1 to 50 msec
- ◆ Communication memory mode EEP, RAM, r\_E
- ◆ Communication protocol (1) SHIMADEN protocol
  - Data length 7 bit, 8bit
  - Parity EVEN, ODD, NONE
  - Stop bit 1bit, 2bit
  - Control code STX\_ETX\_CR, STX\_ETX\_CRLF, @:\_:\_CR
  - Checksum (BCC) ADD, ADD\_two's cmp, XOR, None
  - Communication code ASCII
- ◆ Communication protocol (2) MODBUS ASCII mode
  - Data length 7 bit (fixed)
  - Parity EVEN, ODD, NONE
  - Stop bit 1bit, 2bit
  - Control code \_CRLF
  - Error check LRC check
  - Function code 03H and 06H (Hex) supported
    - 1) 03H Read data
    - 2) 06H Write data
- ◆ Communication protocol (3) MODBUS RTU mode
  - Data length 8 bit (fixed)
  - Parity EVEN, ODD, NONE
  - Stop bit 1bit, 2bit
  - Control code None
  - Error check CRC 16
  - Function code 03H and 06H (Hex) supported
    - 1) 03H Read data
    - 2) 06H Write data

## 20-15 Infrared Communication

- ◆ Communication system Direct communication is possible with a PC through the infrared communication adapter (sold separately)
- ◆ Number of connectable devices 1
- ◆ Infrared communication specification
  - Synchronization system Start-stop synchronization
  - Communication speed 9600 bps
  - Data format 7E1 (7 bits, even parity, 1 stop bit)
  - Control code STX\_ETX\_CR
  - Checksum (BCC) ADD
  - Communication code ASCII
- ◆ Communication protocol SHIMADEN protocol (extended)

## 20-16 General Specifications

- ◆ Data storage Non-volatile memory (EEPROM)
- ◆ Operating environment conditions
  - Temperature -10 to 50°C
  - Humidity 90% RH max. (no dew condensation)
  - Elevation 2000 m above sea level or lower
  - Category II
  - Pollution class 2
- ◆ Storage temperature -20 to 65°C
- ◆ Power voltage 100 to 240 V AC  $\pm 10\%$  (50/60 Hz)
- ◆ Power consumption Max. 22 VA
- ◆ Input noise removal ratio
  - Normal mode 40 dB min. (50/60 Hz)
  - Common mode 120 dB min. (50/60 Hz)
- ◆ Applicable standards
  - Safety IEC61010-1 and EN61010-1  
IEC61010-2-030 and EN61010-2-030
  - EMC EN61326-1
- ◆ Insulation resistance
  - Across I/O terminals and power terminals: 500 V DC 20M $\Omega$  min.
  - Across power terminals and ground terminals: 500 V DC 20M $\Omega$  min.
- ◆ Dielectric strength
  - Across I/O terminals and power terminals: 3000 V AC for 1 minute
  - Across power terminals and ground terminals: 1500 V AC for 1 minute
- ◆ Protective structure Front operating panel only is dust-proof and drip-proof. (equivalent to IP66)
- ◆ Case material PC resin molding (equivalent to UL94V-1)
- ◆ External dimensions 96 x 96 x 111 mm (panel depth: 100 mm) (H x W x D)
- ◆ Mounting Imbedded in panel (using mounting fixtures)
- ◆ Thickness of usable panel 1.0 to 8.0 mm
- ◆ Size of panel cutout 92 (H) x 92 (W) mm
- ◆ Weight 600 g max.

This page left intentionally blank.

产品中有毒有害物质或元素的名称及含量

| 部件名称  | 有毒有害物质或元素 |        |        |                  |               |                 |
|---|-----------|--------|--------|------------------|---------------|-----------------|
|   | 铅 (Pb)    | 汞 (Hg) | 镉 (Cd) | 六价铬<br>(Cr (VI)) | 多溴联苯<br>(PBB) | 多溴二苯醚<br>(PBDE) |
| 印制电路板   | ×         | ○      | ○      | ○                | ○             | ○               |
| 电子元器件   | ×         | ○      | ○      | ○                | ○             | ○               |
| 接线端子  | ○         | ○      | ○      | ○                | ○             | ○               |
| 外壳  | ○         | ○      | ○      | ○                | ○             | ○               |
| ○：表示该有毒有害物质在该部件所有均质材料中的含量均在SJ/T 11363-2006<br>标准规定的限量要求以下。<br>×：表示该有毒有害物质至少在该部件的某一均质材料中的含量超出SJ/T<br>11363-2006 标准规定的限量要求。 |           |        |        |                  |               |                 |

The contents of this Instruction Manual are subject to change without notice.

**Temperature and Humidity Control Specialists**

**SHIMADEN CO., LTD.**

<http://www.shimaden.co.jp/>

Head Office: 2-30-10 Kitamachi, Nerima-ku, Tokyo 179-0081 Japan  
 Phone: +81-3-3931-7891 Fax: +81-3-3931-3089 E-mail: exp-dept@shimaden.co.jp

PRINTED IN JAPAN