

SR73A and 74A Series Digital Controller

Instruction Manual

Thank you for purchasing the Shimaden SR73A and 74A Series. Please check that the delivered product is the correct item you ordered. Please do not begin operating this product until you have read this instruction manual thoroughly and understand its contents.

"Notice"

Please ensure that this instruction manual is given to the final user of the instrument.

Preface

This instruction manual is meant for those who will be involved in the wiring, installation, operation and routine maintenance of the SR73A and 74A series.

This manual describes the care, installation, wiring, function, and proper procedures for the operation of SR73A and 74A series. Keep this manual at the work site during operation of the SR73A and 74A series. While using this instrument, you should always follow the guidance provided herein.

For matters regarding safety, potential damage to equipment and/or facilities, additional instructions are indicated by the following headings:

⚠ WARNING

Exercise extreme caution as indicated. This heading indicates hazardous conditions that could cause injury or death of personnel.

⚠ CAUTION

Exercise extreme caution as indicated. This heading indicates hazardous conditions that could cause damage to equipment and/or facilities.

NOTE

This heading indicates additional instructions and/or notes.

The mark ⊕ designates a protective conductor terminal. Make sure to properly ground it.

The Matters regarding Safety

⚠ WARNING

SR73A and 74A series controllers are designed for controlling temperature, humidity and other physical subjects. It must not be used in any way that may adversely affect the safety, health or working conditions of those who come into contact with the effects of its usage. When used, adequate and effective safety countermeasures must be provided at all times. No warranty, express or implied, is valid in the case of usage without having implemented proper safety countermeasures.

⚠ CAUTION

To avoid damage to the connected equipment, facilities or the product itself due to a fault of the product, safety countermeasure must be taken before usage, such as proper installation of the fuse and the overheating protection device. No warranty, express or implied, is valid in the case of usage without having implemented proper safety countermeasures.

⚠ CAUTION

- The ⚠ mark on the plate affixed to the instrument:
On the terminal nameplate affixed to the case of your instrument, the ⚠ mark is printed. This is to warn you of the risk of electrical shock which may result if the charger is touched while it is energized.
- A means to allow the power to be turned off, such as a switch or a breaker, should be installed in the external power circuit to be connected to the power terminal of the instrument. Fix the switch or the breaker adjacently to the instrument in a position which allows it to be operated with ease, and with an indication that it is a means of turning the power off. The switch or the breaker should meet the requirements of IEC 947.
- Fuse:
Since the instrument does not have a built-in fuse, do not forget to install a fuse in the power circuit to be connected to the power terminal.
The fuse should be positioned between the switch or the breaker and the instrument and be attached to the L side of the power terminal.
Fuse Rating: 250V AC 0.5A/medium lagged or lagged type
Use a fuse which meets the requirements of IEC 127.
- Voltage/current of a load to be connected to the output terminal and the alarm terminal should be within a rated range. Otherwise, the temperature will rise and reduce the life of the product and/or result in problems with the product. For the rated voltage/current, see 8. Specifications on page 15. The output terminal should be connected with a device which meets the requirements of IEC 1010.
- A voltage/current different from that of the input specification should not be added on the input terminal. It may reduce the life of the product and/or result in problems with the product.
For the rated voltage/current, see 8. Specifications on page 15.
For the rated voltage (mV or V) or current (4~20 mA) input, the input terminal should be connected with a device which meets the requirements of IEC1010 as input terminals.
- In the case where the heater break alarm (optional) input is 0~5V DC, the CT input terminal should be connected to an apparatus which meets IEC 1010 requirements.
- As the CT input terminal for the heater break alarm (optional), only the attachment CT should be used. Using anything else may result in problems with the product. For the CT provided, refer to 1-1 Check before Use on page 2. (Except when 0~5V DC input has been selected.)
- The SR73A and 74A series controllers are provided with a draft hole for heat discharge. Take care to prevent metal or other foreign matter from obstructing it. Failure to do so may result in problems with the product and may even result in fire.

- Do not block the draft hole or allow dust or the like to adhere to it. Any rise in temperature or insulation failure may result in a shortening of the life of product and/or problems with the product.
For spaces between installed instruments, refer to 2-4 External Dimensions and Panel Cutout on page 3.
- It should be noted that repeated tolerance tests against voltage, noise, surge, etc., may lead to deterioration of the instrument.

Contents

1. Introduction.....	2
1-1. Check before use.....	2
1-2. Caution for use.....	2
2. Installation and wiring.....	2
2-1. Installation site (environmental conditions).....	2
2-2. Mounting.....	3
2-3. How to remove the instrument out of the case.....	3
2-4. External dimensions and panel cutout.....	3
2-5. Wiring.....	3
2-6. Terminal arrangement.....	3
2-7. Terminal arrangement table.....	4
3. Instruction for front panel.....	4
3-1. Drawing and the name of the parts.....	4
3-2. Instruction for front panel.....	4
4. Screen instruction.....	5
4-1. Power on and initial screen display.....	5
4-2. Alarm type code table.....	5
4-3. Screen change.....	5
4-4. Instruction for screen change and each screen.....	6
4-5. Measuring range code table.....	7
4-6. Supplementary explanation of screens.....	8
5. Operation.....	8
5-1. Setting of set value (SV).....	8
5-2. AT (Auto tuning).....	8
5-3. Setting of alarm.....	9
6. Supplement.....	9
6-1. Auto return function.....	9
6-2. PID (Screen No.2, 4 and 5 of mode 1 screen group).....	9
6-3. Control output characteristics (④ digit of function selecting screen of mode 2 screen group).....	10
6-4. Error message.....	10
7. Instructions on Communication.....	10
7-1. General.....	10
7-2. How to connect SR73A or 74A with host computer.....	10
7-2-1. Control signals.....	10
7-2-2. Connection of RS-422A.....	10
7-2-3. Connection of RS-485.....	11
7-2-4. Terminal resistance.....	11
7-2-5. Control of 3-state output.....	11
7-3. Setting of communication parameters.....	11
7-3-1. Communication mode selecting screen (<i>Ctrl</i>).....	11
7-3-2. Communication address (<i>Addr</i>) setting screen.....	11
7-3-3. Communication data format (<i>DATA</i>) selecting screen.....	11
7-3-4. Communication rate (<i>bPS</i>) selecting screen.....	11
7-3-5. Delay (<i>Delay</i>) setting screen.....	11
7-4. Communication protocol.....	11
7-4-1. Communication procedure.....	11
7-4-2. Explanation of block.....	11
7-5. Text.....	12
7-5-1. Text format.....	12
7-5-2. Data format.....	12
7-5-3. Communication error.....	13
7-5-4. Non-response process.....	13
7-5-5. Restrictions by commands, etc.....	13
7-6. A list of transmitted/received data.....	14
7-6-1. Read command.....	14
7-6-2. Write command.....	14
8. Specifications.....	15

1. Introduction

1-1. Check before use

This product has been fully checked for quality assurance prior to shipment. Nevertheless, you are requested to make sure that there is no error, damage or shortage of delivered items by confirming the model codes and checking the external view of the product and the number of accessories.

Confirmation of Model Codes:

Check the model codes stuck to the case of the product to ascertain if the respective codes designate what was specified when you ordered the product, referring to the following code table:

SR73A-8 Y1- 1 5 0 Item	Code and Description
1. Series	SR73A and 74A
2. Input	8: Multi-input Thermocouple, R.T.D., Voltage (mV)
3. Output	4: Current (mA) 6: Voltage (V)
4. Optional function	Y1: Contact I1: Current P1: SSR-drive voltage V1: Voltage
5. Communication function	0: None 1: Alarm 2: Alarm + Heater break alarm (30, 0A)
6. Remarks	3: Alarm + Heater break alarm (50, 0A) 4: Set value bias
	5: Alarm + Set value bias
	6: Alarm + Heater break alarm (30, 0A) + Set value bias
	7: Alarm + Heater break alarm (50, 0A) + Set value bias
	A: Alarm + Heater break alarm (0~5V input, corresponding to 0~500A)
	B: Alarm + Heater break alarm (0~5V input) + set value bias
	5 : RS-485 6 : RS-422A
	C: Without 9: With

Checking accessories:

Instruction manual 1 set
Unit decal 1 sheet

Current transformer (CT) for heater break alarm:
included with the heater break alarm option (Except when 0~5V DC input has been selected, though.)
TYPE CTL-6-S for 30A selection
TYPE CTL-12-S36-8 for 50A selection

Note: Contact our representative concerning any problems with the product, accessories or related items.

1-2. Caution for use

- Avoid operating keys of the front panel with hard or sharp objects or motions. Lightly touch the operating keys with finger tip for operation.
- Avoid using solvents such as thinner; wipe gently with a dry cloth.

2. Installation and wiring

2-1. Installation site (environmental conditions)

CAUTION

In the case where there is an intention to operate this product at one of the following sites, be aware that the occurrence of fire and/or other dangerous situations is considerable. Exercise caution and avoid these places when selecting an operational site.

- Where flammable gas, corrosive gas, oil mist and particles that can deteriorate electrical insulation are generated or are abundant.
- Where the temperature is below -10 °C or above 50 °C.
- Where the relative humidity is 90%RH or below dew point.
- Where highly intense vibration or impact is generated or transferred.

- (5) Near high voltage power lines or where inductive interference can affect the operation of the product.
- (6) Dew drops or direct exposure to sun light.
- (7) Where the elevation is in excess of 2,000 m.

Note: The environmental conditions belong to the installation category II of IEC 664 and the degree of pollution is 2.

2-2. Mounting

- (1) Machine the mounting hole by referring to panel cutout in section 2-4.
- (2) Applicable thickness of the mounting panel is from 1.0 to 3.5 mm.
- (3) As this product provides mounting fixture, insert the product from the front panel for installation.

2-3. How to remove the instrument out of the case

CAUTION

When the instrument is removed/replaced in the case, make sure the power is off. If it is done while the power is on, it may lead to problems with the product and/or other problems.

There is no need to remove your SR73A and 74A series controllers out of the case. Nevertheless, should the need arise, for example, for replacement, follow the steps described below:
 Insert a minus screwdriver of 6mm ~ 9mm into the opening (where packing is exposed) of the front case and rotate the screwdriver while pushing up the lock lever behind the packing. Once the instrument comes out by a few millimeters, you can remove it by hand.

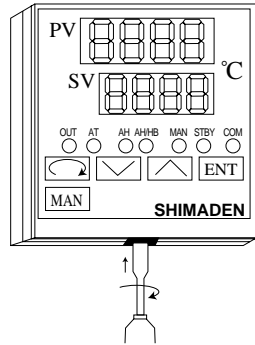

2-4. External dimensions and panel cutout

SR73A External dimensions

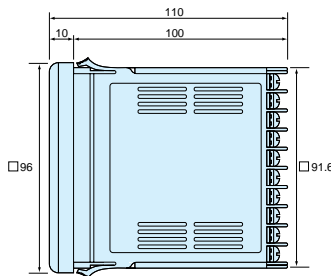

SR73A Panel cutout

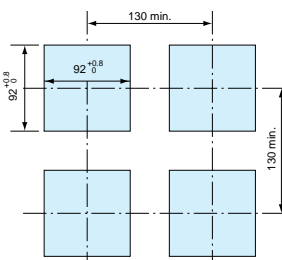

SR74A External dimensions

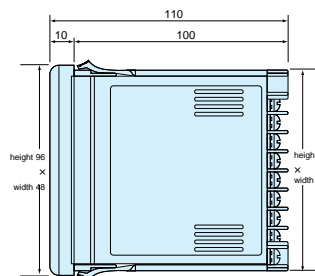

SR74A Panel cutout

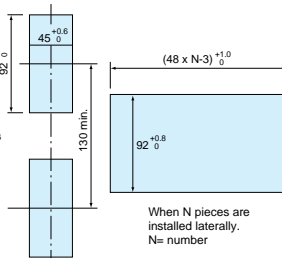

(unit : mm)

Dimension of current transformer (CT) for heater break alarm

• For 0-30A (CTL-6-S).....For 0-50A (CTL-12-S36-8)

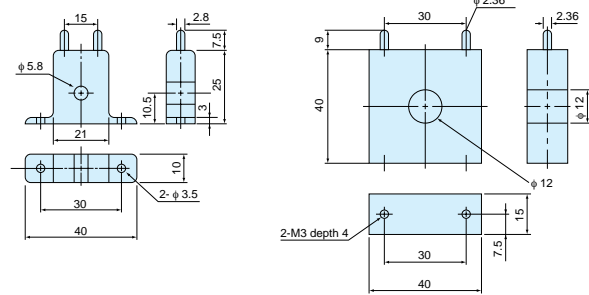

(unit : mm)

2-5. Wiring

WARNING

- Always disconnect this product from any power source during wiring operation to prevent electrical shock.
- Be certain that the protective conductor terminal (⊕) is properly grounded. Otherwise, a serious electric shock may result.
- Avoid touching the wired terminal and charged devices while supplying power.

- (1) Wiring operation should be done according to the instruction for the terminal arrangement in section 2-6. Exercise care that no wrong connection is made.
- (2) Crimp terminal should accommodate the M3.5 screw and should have a width of less than 7mm.
- (3) For thermocouple input, select the compensation wire suitable to the thermocouple type.
- (4) For R. T. D. input, leads should be less than 5Ω in resistance and three leads should have the same resistance.
- (5) Input signal line should be conducted safely apart from the high voltage power line.
- (6) Shield wiring (single point grounding) is effective for static induction noise.
- (7) Short interval twisted pair wire for input signal is effective for electromagnetic induction noise.
- (8) For power line, use wire or cable which is 1mm² or more in sectional area and of which the performance is equal to or higher than that of 600V vinyl insulated wire.
- (9) Earth grounding should be performed with earth resistance less than 100Ω and with wire thicker than 2mm².

2-6. Terminal arrangement

SR73A

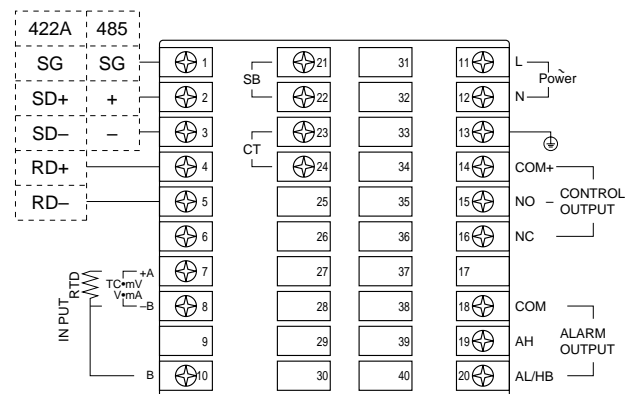

SR74A

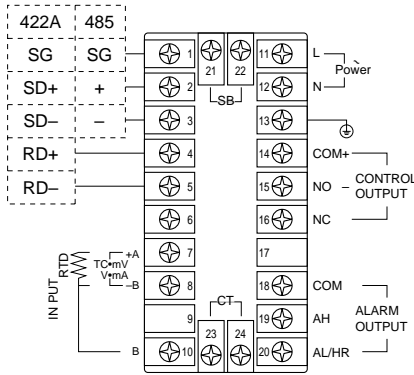

2-7. Terminal arrangement table

Name of terminal and description	Terminal number
	SR73A and 74A
Power terminal 100-260V AC±10% 50/60Hz 12VA	11-12
Protective conductor terminal (\oplus)	13
Input terminal R. T. D. A, Thermocouple, Voltage, Current + R. T. D. B, Thermocouple, Voltage, Current - R. T. D. B	7 8 10
Output terminal Contact: COM, SSR Drive voltage, Voltage, Current + Contact: NO, SSR Drive voltage, Voltage, Current - Contact: NC	14 15 16
Communication terminal For RS-422A For RS-485 SG SG SD+ + SD- - RD+ RD-	1 2 3 4 5
Alarm output (option) terminal COM Contact rating 240V AC 1.5A (resistive load) AH Higher limit alarm AL/HB Lower limit alarm or heater break alarm	18 19 20
Set value bias (option) input terminal	21-22
Heater break alarm (option) CT input terminal	23-24

Note: For Thermocouple, Voltage, and Current input, measurement error results by connection between B and B terminal.

3. Instruction for front panel

3-1. Drawing and the name of the parts

This is an example of the front panel of SR73A.

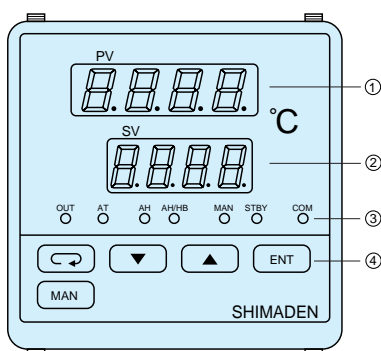

Name of parts

- ①: Measured value (PV) display
- ②: Set value (SV) display
- ③: Monitor LED
- ④: Key switches

3-2. Instruction for front panel

- ①: Measured value (PV) display (green)
 - (1) Displays current measured value on the mode 0 basic screen.
 - (2) Displays parameter type on each parameter screen.
- ②: Set value (SV) display (orange)
 - (1) Displays set value on the mode 0 basic screen.
 - (2) Displays selected item and set value on each parameter screen.
- ③: Monitor LED
 - (1) OUT (output) monitor LED (green)
 - For contact or SSR drive voltage output, a light turns on for output ON and turns off for output OFF.
 - For current or voltage output, the light intensity changes proportionally to the output altitude.
 - (2) AT (auto tuning) monitor LED (green)
 - On selection by \square \square , ON turns on AT waiting (\square key), flashes on AT execution.
 - (3) AH alarm output monitor LED (red)
 - Turns on for higher limit alarm output ON.
 - (4) AL/HB alarm output monitor LED (red)
 - Turns on for lower alarm output ON or heater break alarm ON.
 - (5) MAN (manual control output) monitor LED (green)
 - Flashes when control output is in manual operation.
 - (6) STBY (control output stop) monitor LED (green)
 - Turns on when the control output stop mode is selected.
 - (7) COM (communication) monitor LED (green)
 - Turns on when the remote communication mode is selected.
- ④: Key switches
 - (1) \square (parameter) key
 - Press on set screen to move to next set screen.
 - Keep pressing three (3) seconds for function of move key between basic screen of the mode 0 screen group and direct call screen of mode 1 screen group.
 - (2) \square (down) key
 - Press on the set screen to flash the point of the least digit and to reduce data or back increment data.
 - (3) \square (up) key
 - Press on the set screen to flash the point of the least digit and to increase data of increment data.
 - (4) \square (entry/registration) key
 - Press on the set screen of the mode 0 screen group and mode 1 screen group to fix the data changed by the \square , \square keys and to extinguish flash of the point.
 - The function selecting screen, of the mode 2 screen group, registers data of the point flashing digit and simultaneously shifts a data changeable digit (the point flashing digit).
 - The input scaling screen, of the mode 2 screen group, registers data and shifts a parameter capable of being set (in the row in which the rightmost point is flashing).
 - Press the key for five seconds and it functions to change the basic screen of the mode 0 screen group to the function selecting screen of the mode 2 screen group and vice versa.
 - (5) \square (MAN) (manual) key
 - Pressing this key on the control output screen changes automatic control output to manual control output and vice versa. During manual control output, the MAN monitor LED flashes.
 - The \square key does not function in the control output stop mode.

4. Screen instruction

4-1. Power on and initial screen display

After turning on power, the display shows each power on initial screen for approx. 1.5 seconds, then moves into the basic screen of the mode 0 screen group.

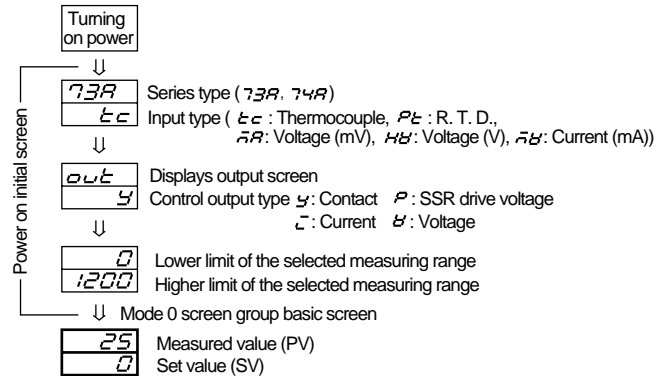

4-2. Alarm type code table

Alarm code	AH assignment	With/Without inhibit action	AL/HB assignment	With/Without inhibit action
0 (0)	Not assigned	-----	Not assigned	-----
1 (1)	Higher limit deviation value	Without inhibit action	Lower limit deviation value	Without inhibit action
2 (2)	Higher limit absolute value	Without inhibit action	Lower limit absolute value	Without inhibit action
3 (3)	Higher limit deviation value	With inhibit action	Lower limit deviation value	With inhibit action
4 (4)	Higher limit absolute value	With inhibit action	Lower limit absolute value	With inhibit action
5 (5)	Higher limit deviation value	Without inhibit action	Heater break	-----
6 (6)	Higher limit absolute value	Without inhibit action	Heater break	-----
7 (7)	Higher limit deviation value	With inhibit action	Heater break	-----
8 (8)	Higher limit absolute value	With inhibit action	Heater break	-----

Note: In the above table, the alarm codes 5 through 8 are selectable when the apparatus has the optional function of heater break alarm.

4-3. Screen change

- Screen change from mode 0 group to mode 1 group
 - Pressing the key for three seconds on the basic screen of the mode 0 screen group changes it to the direct call screen of the mode 1 screen group and vice versa.

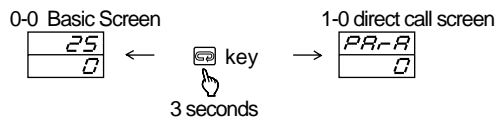

- Screen change from mode 0 group to mode 2 screen group
 - Pressing the key for five seconds on the basic screen of the mode 0 screen group changes it to the function selecting screen of the mode 2 screen group and vice versa.

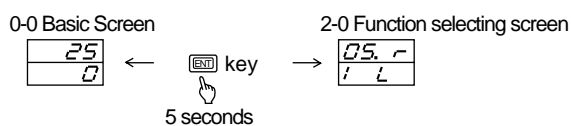

- Screen change within mode 0 screen group
 - By pressing the key, the screen changes.
- Screen change within mode 1 screen group
 - Two methods are used for screen change within mode 1 screen group. One is to press the key as shown on above mode 0 screen group. The other is to mode the screen directly by indicating screen No. on the top direct call screen.

Example: Direct calling the screen No.8 PV bias value set screen

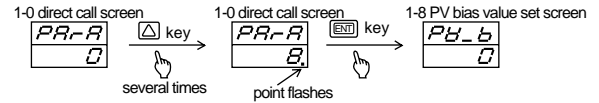

- Selecting and setting digit to change of function selecting screen of mode 2 screen group
 - When the function selecting screen is displayed, the point of selectable digit flashes.
 - By pressing key, the selectable digit (digit whose point is flashing) moves.
 - In case of changing the set value, flash the point to be changed with key, select data with the keys and press key again to register the set value and move selectable digit.

Example: changing the control output characteristics from r (heating) to d (cooling)



* "." on the screen shows the selectable digit (digit whose point is flashing).

Note: In case of changing data and pressing key longer than 5 seconds, the screen moves to mode 0 basic screen without a data registration. It requires a data verification with key and screen change.

- Shifting setting items on input scaling screen of mode 2 screen group and setting method
 - Pressing the key on the function selecting screen calls the input scaling screen onto the display. The decimal point in the rightmost position on the top row flashes. Press the or key to change the lower limit value and press the key to register the data.
 - Upon registering the lower limit value data, the decimal point in the rightmost digit in the bottom row begins to flash. Change the higher limit value by pressing the or key and register it by means of the key.
 - Upon registering the higher limit value data, the decimal points in the rightmost digits of the bottom and top rows flash. Change the positions of the decimal points by pressing the or key and register it by means of the key.
 - Each time the key is pressed, the flashing decimal point in the rightmost digit moves from the top row → bottom row → top and bottom rows → top row →.
 - In case the lower limit value and the higher limit value are set to produce a difference which is less than 100 counts or more than 5000 counts, the higher limit value is forced to change to +100 or +5000 counts. The higher limit cannot be set to be less than a lower limit value +100 counts or more than a lower limit value +5000 counts.

4-4. Instruction for screen change and each screen

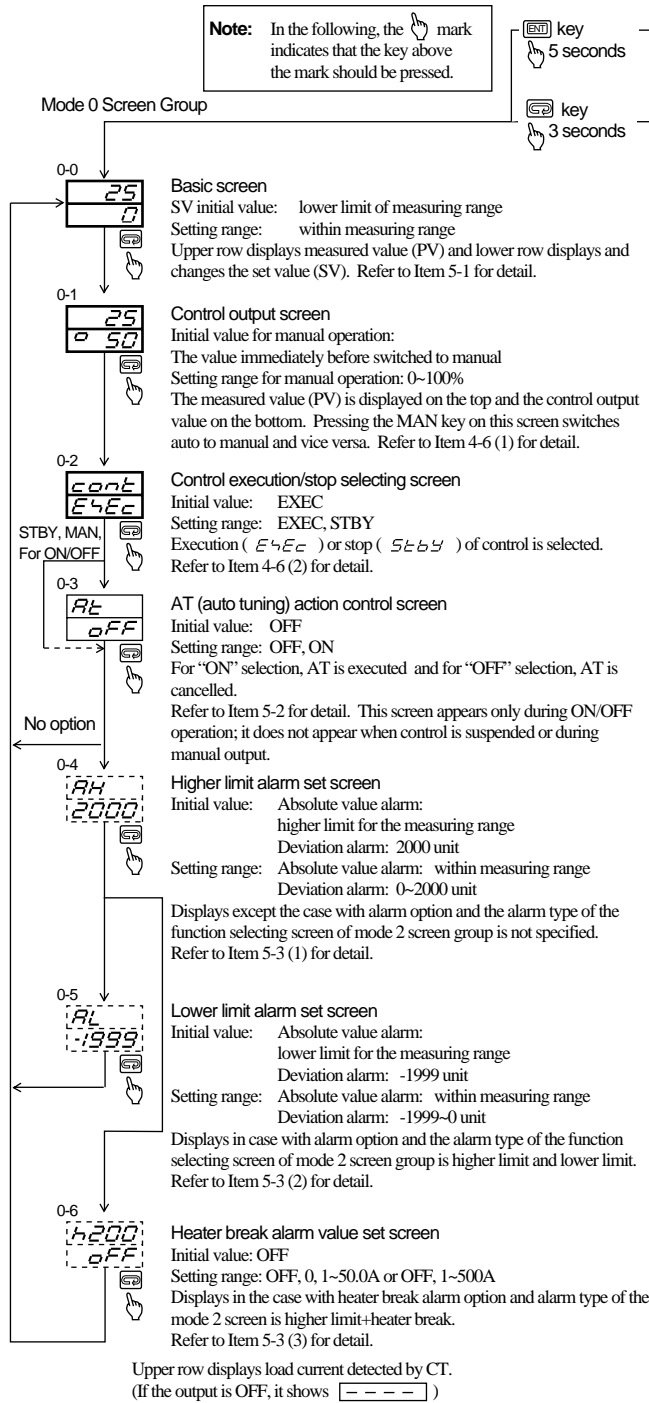

NOTE: The heater break alarm can be added if the instrument has alarm option and the control output is the contact type or the SSR drive voltage type.

Heater break alarm

- Set the alarm level at approx. 85% of the normal load current. In case of large current variation, set larger value.
If multiple heaters are connected in parallel, set a larger value to output alarm for single heater break.
- If "OFF" is selected, no alarm output is obtained. Selecting "OFF" during alarm output, the alarm output is canceled.
- For case when heater break function is not applicable to direct current load, phase controlling current and three phase heater.
- Connecting current transformer (CT)
One of the load line wires passes through the hole of the custom CT.
Wire from the secondary side terminal of CT to the CT input terminal of the instrument.

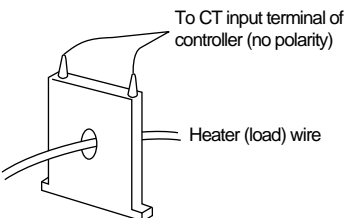

NOTE: Two types of the heater break CT of 30A and 50A are available, the type selected upon ordering is shipped with the product as an accessory. Note the maximum current to be set is 50.0A for both types. CT is not provided when 0~500A is designated.

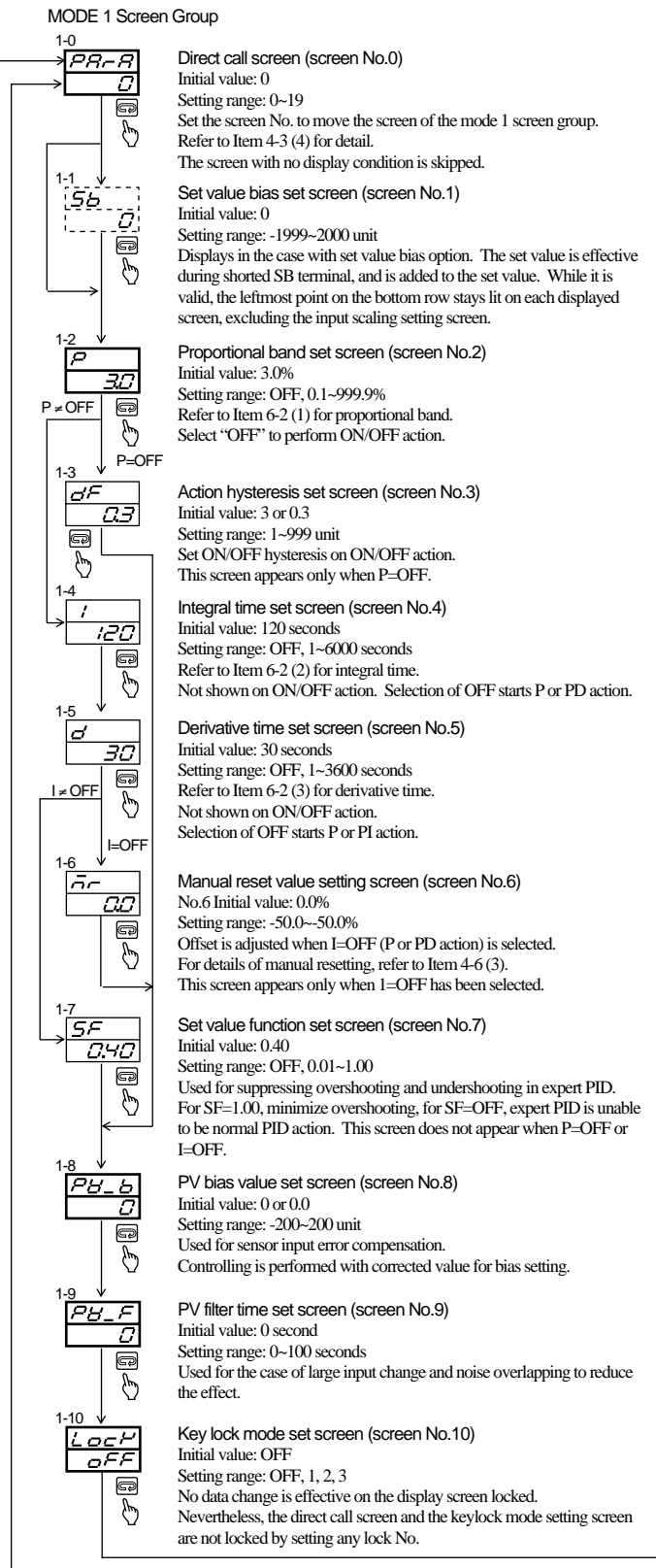

Lock Nos. and Ranges to be locked are as follows:

Lock No.	Range of Screens to Be Locked
OFF	Release of lock
1	Other screens than basic, control output, AT action control and communication mode screens
2	All except basic screen
3	All screens

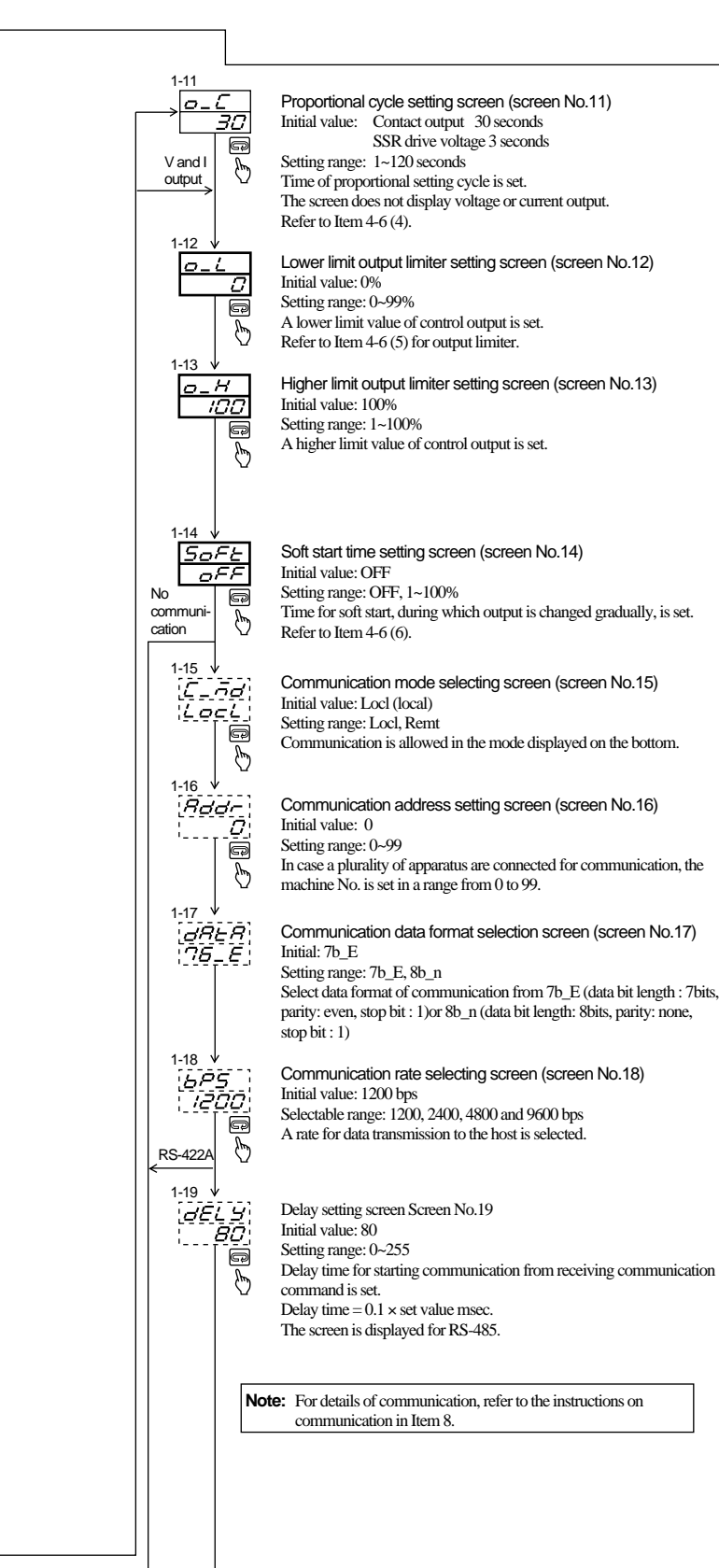

Mode 2 Screen Group (Function selecting screen)

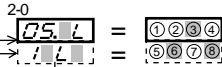

Use key to move select digit and data registration, the selectable digit is indicated by flashing point.

NOTE: If it is on auto tuning execution or key lock is set on lock No.1, 2 or 3, no selection can be performed even if the digit point is flashing.

Digits ⑤ and ⑦ are not shown in case of no option. Digits of ③, ⑥ and ⑧ are not displayed.

- ①・②: Measuring range code select digit
Initial value: Multi 05, Voltage (V) 81, Current 95 fixed.
Selecting two digits from "4-5. Measuring range code table".
- ④: Control output characteristic select digit
Initial value:
 : RA (heating characteristics)
 : DA (cooling characteristics)
Refer to Item 6-3.
- ⑤: Alarm type select digit
Initial value: /
Select from "4-2. Alarm type code table".
- ⑦: Heater break alarm action mode select digit
Initial value:
 : Lock mode and : REAL mode.
Refer to Item 5-3 (3).

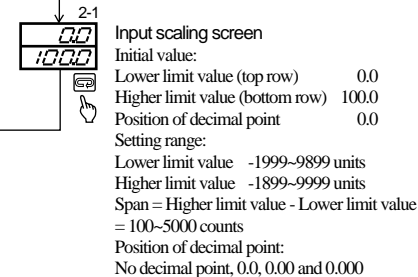

Scaling is done for linear input (mV, V or mA).
The screen is only for monitoring and no setting is possible in the case of sensor input.
Refer to Item 4-3 (6) for details.

4-5. Measuring range code table

Input type		Code	Measuring Range	Code	Measuring Range	
Multi input	Thermocouple input	*1B	01 0 ~ 1800°C	12	0 ~ 3300°F	
		R	02 0 ~ 1700°C	13	0 ~ 3100°F	
		S	03 0 ~ 1700°C	14	0 ~ 3100°F	
		K	04 -100 ~ 400°C	15	-150 ~ 750°F	
		K	05 0 ~ 1200°C	16	0 ~ 2200°F	
		E	06 0 ~ 700°C	17	0 ~ 1300°F	
		J	07 0 ~ 600°C	18	0 ~ 1100°F	
		T	08 -199.9 ~ 200.0°C	19	-300 ~ 400°F	
		N	09 0 ~ 1300°C	20	0 ~ 2300°F	
		*2U	10 -199.9 ~ 200.0°C	21	-300 ~ 400°F	
	*2L	11 0 ~ 600°C	22	0 ~ 1100°F		
	R. T. D.	Pt 100	31	-200 ~ 600°C	39	-300 ~ -1100°F
			32	-100.0 ~ 100.0°C	40	-150.0 ~ 200.0°F
			33	-50.0 ~ 50.0°C	41	-50.0 ~ 120.0°F
34			0.0 ~ 200.0°C	42	0 ~ 400°F	
JPt 100		35	-200 ~ 600°C	43	-300 ~ -1100°F	
		36	-100.0 ~ 100.0°C	44	-150.0 ~ 200.0°F	
		37	-50.0 ~ 50.0°C	45	-50.0 ~ 120.0°F	
		38	0.0 ~ 200.0°C	46	0 ~ 400°F	
Voltage mV	0 ~ 10	71	Initial value: 0.0~100.0	Thermocouple B, R, S, K, E, J, T, N: JIS/ANSI/IEC R. T. D.		
	10 ~ 50	72	Conditions of scaling	Pt100 : Present JIS/IEC		
	0 ~ 100	73	Scaling setting range: -1999~9999,	JPt100 : Former JIS		
Voltage V	0 ~ 1	81	Span: 100~5000 counts	*1 Thermocouple B: Accuracy not guaranteed for temperatures below 400 °C (750 °F).		
	0 ~ 5	82	Position of decimal point:	*2 Thermocouple U, L: DIN43710		
	0 ~ 10	83	No decimal point, the first, second and third decimal places			
Current mA	4 ~ 20	95				

Note: For details of communication, refer to the instructions on communication in Item 8.

NOTE: Screen flame on Item 4-4 is as follows:

- Screens always shown during key operation.
- Screens shown during case with option or selected option.
- Screens shown or skipped depending on the type of output or the setting status of control action mode.

In case measuring range is modified, set values, alarm action point and other related values are all initialized.
NOTE: In case types of Alarms are changed, values are initialized.

4-6. Supplementary explanation of screens

(1) 0-1 Control Output Screen

- During manual control an output value is set on this screen. In automatic control, it is only for monitoring.
- For switching automatic control to manual, press the **MAN** key on the control output screen.
- The MAN monitor LED flashes during manual control and goes out when control is changed to auto.
- This screen is only for monitoring in the stop mode, when AT is ON, or keylock is set at 2 or 3.
- Manual control output is released if the stop mode is selected or the type of input or the measuring range is changed during manual control.
- For changing the manual output value, the **△** and **▽** keys are used. It is not necessary to press the **ENT** key.
- During manual control, the setting range of control output is between 0 and 100%. In case an output limiter has been set, that value serves as the higher/lower limit of the setting range.
- In ON/OFF action (P=0), manual control output should be at 0% or 100% (For V and I output, lower limit output limiter or higher limit output limiter).
- When auto is changed to manual, the action becomes balanceless and bumpless. If the measured value (PV) is out of the proportional band, it does not attain balanceless and bumpless action.
- If power is turned off during manual control output and is turned on again, the condition is stored in the memory.

Note: Moving to another screen while maintaining the manual mode is possible. In this case, it should be noted that control output is made manually. The apparatus is in the manual mode when the MAN monitor LED is flashing.

(2) 0-2 Control Execution/Stop Screen

- Use the **△** and **▽** keys to select control execution (EXEC) or stop (STBY). Then register it by means of the **ENT** key.
- Upon selecting stop, the STBY monitor LED turns on and the control output display turns to 0%.
- Upon selecting execution, the mode changes to automatic control; it is not possible to go directly from the stop to the manual mode. When control is being executed, the STBY monitor LED remains unlit.
- Even at stop, the alarm works.
- When AT is ON or 1, 2 or 3 of keylock has been selected, no change is allowed.

(3) 1-6 Manual Reset Value Setting Screen

- In the PID operation, an offset is corrected automatically by I, i.e., integral calculation. When I is set at OFF, this correction is not made and output is manually increased or decreased for correction. This is called manual reset (MR).

(4) 1-11 Proportional Cycle Setting Screen

- In the case of contact output or SSR drive voltage output, time in which output is ON + time in which it is OFF in the proportional band, that is, proportional cycle time is set.

(5) 1-12, 1-13 Lower Limit and Higher Limit Output Limiters Setting Screens

- The output limiters function effectively to maintain the lowest temperature, to suppress control overshoot by limiting control output to minimum and maximum values set.
- In the output limiters, priority is given to the lower limit value. Therefore, when the lower limit is set at a value higher than the higher limit value, the higher limit value is forced to be the lower limit value + 1%. Therefore, the higher limit value cannot be set to be less than the lower limit value + 1%.

(6) 1-14 Soft Start Time Setting Screen

- Soft start is the function selected to raise control output gradually in the beginning of control. It is effective in preventing excessive current from flowing into a heater or similar apparatus.
- Soft start functions in the following cases:
 - ① Upon applying power in the auto mode
 - ② When control stop (STBY) is changed to control execution (EXEC)
 - ③ When scale-over is restored to the normal state (in auto mode)

The above are on condition that soft start time and proportional band are not set at OFF.

- In the following cases, the soft start function is released.
 - ① Soft start time has elapsed without problem.
 - ② Auto is changed to stop or manual mode during the execution of soft start.
 - ③ Soft start time or proportional band is changed to OFF during the execution of soft start.
 - ④ The measurement range code is changed during the execution of soft start.
 - ⑤ Control output characteristic is changed during the execution of soft start.
 - ⑥ Scale-over of a measured value occurs during the execution of soft start.
 - ⑦ Control output falls to a level below the output value of soft start during the execution of soft start.
- Auto tuning is unable to be carried out during the execution of soft start.

5. Operation

5-1. Setting of set value (SV)

- (1) Press the **△** or **▽** key to set set value. Keep pressing it to flash the point of the least digit of set value and increase (or decrease) value.
- (2) After confirming the value to coincide the set value, press **ENT** to register the data.
- (3) After registration of the data, the point of the least digit goes off.

Example: Setting set value to 500 °C.

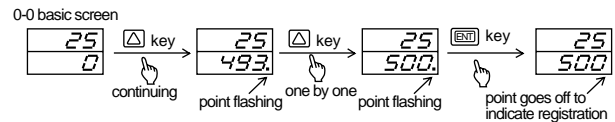

5-2. AT (Auto tuning)

(1) Execution of AT action

- By pressing the **△** or **▽** key on AT action control screen, **OFF** display on lower row turns into **ON** and the point of the least digit starts flashing, then the LED for AT monitoring turns on to indicate AT standby. Press **ENT** key to start AT action with point going off and LED for AT monitoring flashing.

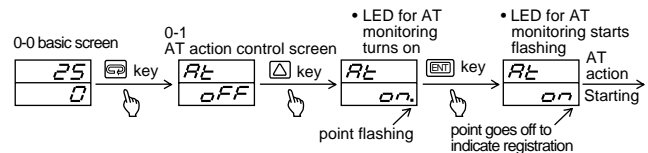

- When AT is carried out, ON/OFF action of output is repeated several times, with the set value as the border line, to make PID values stored in the memory and terminates. At the same time, control is started by using stored PID constants. The AT monitor LED goes out and the display on the AT action control screen changes to **OFF**.

(2) Abort of AT

To abort the AT action, by showing the AT action control screen, press the or key to select OFF and press key to abort AT and LED for AT monitoring also goes off.

Note: When the AT action is aborted, each value for PID is not changed.

(3) AT unable for following conditions.

- When the control stop mode is on (The AT screen is not displayed.)
- During manual output control (The AT screen is not displayed.)
- The proportional band is OFF setting (ON/OFF action). (The AT screen is not displayed.)
- Lock No.2 or 3 is selected on the key lock set screen.
- PV (measured) value is over the scale.
- During the execution of soft start

(4) AT is automatically canceled in the following condition during AT execution.

- Duration equal to or longer than 2 hours passed in the output level of 0% or 100%.
- Power shutdown.
- PV (measured) value is over the scale during AT execution.

(5) The items enable to be set are as follows:

- Level setting of the higher limit alarm.
- Level setting of the lower limit alarm or heater break alarm.
- Screen number setting and key lock setting on the direct call screen of mode 1 screen group.

(6) Relationship between AT and set value bias is as follows;

- When SB terminal is shorted before AT execution, AT executes in the condition with SV+set value bias.
- When SB terminal is opened during AT execution mentioned in the above, AT executes with SV+set value bias condition, then controlled with SV condition after completing AT execution.
- When SB terminal is opened, AT executes with SV condition.
- When SB terminal is shorted during AT execution mentioned in the above, AT executes with SV condition, then controlled with SV+set value bias condition after completing AT execution.

5-3. Setting of alarm

(1) Higher limit alarm setting

- The higher limit alarm set screen is shown in case where alarm option is added and the higher limit alarm of the alarm type select digit on the function selecting screen of the mode 2 screen group is selected.
- Higher limit deviation value alarm is output for measured value to be greater than set value + alarm set value.
- For higher limit deviation value alarm, if set value + alarm set value exceeds the higher limit of the measuring range, the action point is the higher limit of the measuring range.
- Higher limit absolute value alarm outputs alarm signal for the measured value exceeds the alarm set value.
- With the or key, value at which the alarm signal should be output is selected and registered with key.

Example 1:

In case of setting the alarm action point at 600 °C for higher limit deviation value alarm. Set value is 500 °C.

As 500 °C + X °C = 600 °C, X=600-500 = 100 °C should be set.

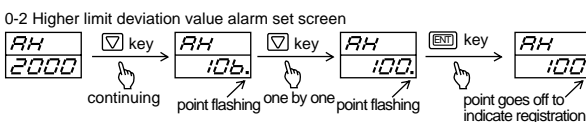

Example 2:

In case of setting the alarm action point at 600 °C for higher limit absolute value alarm.

The set point is action point.

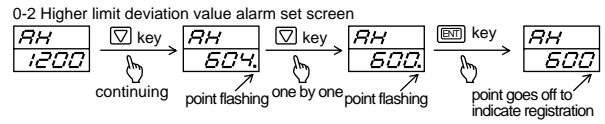

(2) Lower limit alarm setting

- The lower limit alarm set screen is shown in case where alarm option is added and the lower limit alarm of the alarm type select digit on the function selecting screen of the mode 2 group screen group is selected.
- Lower limit deviation value alarm is output for measured value to be less than set value + (alarm set value).
- For lower limit deviation value alarm, if set value + (alarm set value) is less than the lower limit of the measuring range, the action point is lower limit of the measuring range.
- Lower limit absolute value alarm outputs alarm signal for the measured value is less than the alarm set value.
- With the or key, value at which the alarm signal should be output is selected and registered with key.

(3) Heater break alarm setting

- The heater break alarm value setting screen is displayed when the apparatus is equipped with the optional heater break alarm function and heater break alarm is selected in the alarm type selection digit of the function selecting screen of the mode 2 screen group. The top row shows for monitoring purposes the value of the presently flowing current detected by CT and the bottom row shows the set value of the alarm current.
- When OFF is set as the heater break alarm value, the heater break alarm does not function.
- By setting OFF during heater break alarm signal output, heater break alarm output is terminated.
- For set value other than OFF, heater break alarm signal is output if the current that flows in case where control output (contact or SSR drive voltage) is ON, is less than set value.
- If LOCK mode is selected at heater break alarm action mode select digit on the function selecting screen of the mode 2 screen group and the break alarm signal is output, alarm signal is only terminated by changing the break alarm value into OFF or shutting down power.
- If REAL mode is selected and heater current is less than current value being set, break alarm signal is generated. If heater current exceeds the current threshold (0.1A), output of break alarm is terminated.
- Set the heater break alarm current value by means of the or key and register it by using the key.

6. Supplement

6-1. Auto return function

In case there is no key operation for three minutes on each of the screens except the control output screen and the heater break alarm value setting screen, the basic screen of the mode 0 screen group is displayed (auto return).

6-2. PID (Screen No.2, 4 and 5 of mode 1 screen group)

PID values are automatically set by performing auto tuning, modification may be required for object to be controlled.

If auto tuning is not performed, PID value should be set.

- (1) P (proportional action)
Control output rate (%) is set for measuring range.
Control output value changes in proportion with measured value (PV) and set value (SV).
For wide proportional band, change of control output is small relative to deviation. The narrower the proportional band is, the larger the output variation is and the more intense proportional action is. Too narrow proportional band causes ON-OFF like action with oscillation.
- (2) I (integral time)
A function that compensates the offset created by proportional action. Effect of compensation is weaker for longer integral time and is intensified by shortening time. Too short integral time causes integrating hunting and may result in wavy operation.
- (3) D (derivative time)
Improves stability of control by reducing overshooting of integration from expected change of the control output. Effect of compensation is weaker for shorter derivative time and is intensified for longer time. Too long derivative time may result in oscillating operation.

6-3. Control output characteristics (④ digit of function selecting screen of mode 2 screen group)

Control output characteristics determines the control output direction according to the measured value (PV) relative to the set value (SV).

- (1) \curvearrowright (RA characteristics)
Control output increases for lower measured value relative to set value, it is used for heating on temperature control.
- (2) \curvearrowleft (DA characteristics)
Control output decreases for lower measured value relative to set value, it is used for cooling on temperature control.

6-4. Error message

- (1) Defect of measuring input

HHHH In case of thermocouple break, R.T.D. A break and PV being approx. 10% greater than higher limit of measuring range.

LLLL In case of PV being approx. 10% less than the lower limit of measuring range with inverted polarity of input wiring.

CHHH Cold junction (CJ) defect to higher side for thermocouple input.

CHLL Cold junction (CJ) defect to lower side for thermocouple input.

BB-- Break of B or B and multiple break of A, B, B upon R.T.D. input

- (2) Defect of Heater Break Alarm CT Input

HBHH The CT input value exceeds 55A (550A for 0~5V DC input).

HBLL The CT input value falls to -5A (-50A for 0~5V DC input) or lower.

Note: Message of heater break alarm is only displayed on heater break alarm set screen.

---- is shown when output is OFF. It is not defective.

Note: Contact to us or our representative in case of any defect regarding this product.

7. Instructions on Communication

7-1. General

Section 7 deals with communication interface, which is an optional function, and communication procedure.

For the SR73A and 74A series, two types of communication interface, RS-422A and RS-485 are available. Each enables a personal computer or the like to set and read various data by the use of signals which conform with EIA standards.

RS-422A and RS-485 are communication standards established by the Electric Industries Association (EIA), which are meant for electrical or mechanical matters, the so-called hardware, but not for the software portion of the data transmission procedure.

Accordingly, communication even with an apparatus having the same interface cannot be made unconditionally. It requires a thorough understanding of specifications and procedures.

The use of RS-422A or RS-485 allows a plurality of apparatuses to be connected in a parallel configuration. It is also possible to use a line converter for conversion of RS-232C to/from RS-422A and RS-232C to/from RS-485.

7-2. How to connect SR73A or 74A with host computer

7-2-1. Control signals

Since the apparatus is provided with input/output transmitting and receiving data lines and an earthing line for signals but not with any other signal line, control signals should be processed by the host side.

The method of processing differs from system to system and connection details should meet requirements of the host computer. Examples of connection are shown in the following.

7-2-2. Connection of RS-422A

- (1) The logical levels of input and output of this apparatus are basically as follows:

Mark state $**_ - < **_ +$ (Example: SD- < SD+)

(including the state in which communication is not carried out)

Space state $**_ - > **_ +$ (Example: SD- > SD+)

However, since the impedance of SD+ and SD- of this apparatus is high until just before transmission, the above levels are output just before commencing transmission.

- (2) Example of Connection of RS-422A

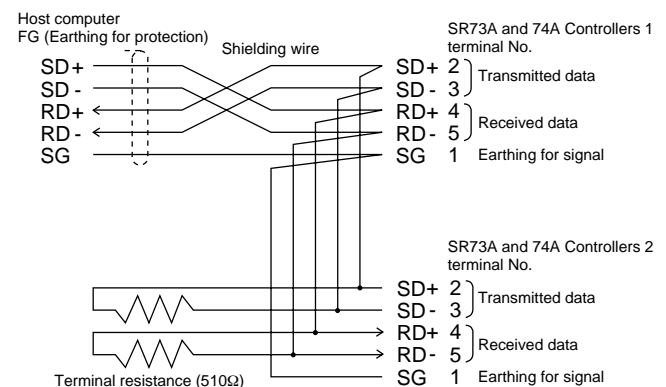

Note: Some line converters between RS-232C and RS-422A may have the following indication for terminal (connector) output. If that is the case, logical levels should be checked before connection.

Example: Mark state $T \times D+ > T \times D-$
 Space state $T \times D+ < T \times D-$

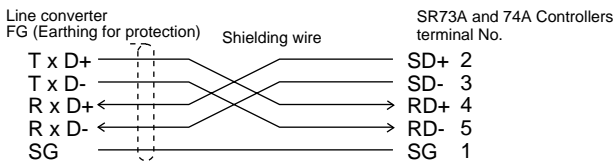

7-2-3. Connection of RS-485

(1) The logical levels of input and output of this apparatus are basically as follows:

Mark state -Terminal < +Terminal

(including the state in which communication is not carried out)

Space state -Terminal > +Terminal

However, since the impedance of +terminal and -terminal of this apparatus is high until just before transmission, the above levels are output just before commencing transmission.

(2) Example of Connection of RS-485

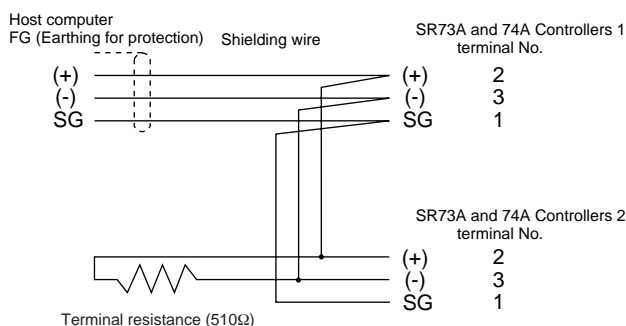

7-2-4. Terminal resistance

As SR73A and SR74A are not provided with terminal resistance, connect a 510Ω resistance to only the last (the furthest from the host) station.

Note: If terminal resistance is connected to two or more, correct action is not guaranteed.

7-2-5. Control of 3-state output

- Since RS-422A and RS-485 employ the multi-drop system, in order to prevent signals from colliding, transmission output should be controlled to maintain high impedance while communication is not being made or signals are being received.
- It should be controlled so that high impedance turns to the normal state of output immediately before starting transmission and high impedance is restored immediately when transmission ends. Because 3-state control is delayed by about 3 msec. maximum from the transmission of the end bit of the end character, a delay time of about 4 msec. should be provided in case transmission is started immediately.

7-3. Setting of communication parameters

There are four communication-related parameters to be set as shown below. They are set by means of front keys except for changing the communication mode from remote to local.

- [L-R] Communication mode
- [Addr] Communication address
- [dRFR] Communication data format
- [bps] Communication rate
- [delay] Delay

7-3-1. Communication mode selecting screen (L-R)

(1) Local Mode (L)

The COM lamp on the front panel goes out to allow the setting to be changed by the use of the front keys. In communication, only the change from local to remote and the read commands are valid.

(2) Remote Mode (R)

The COM lamp on the front panel turns on and the commands for read and write through communication become valid.

Front key operation works only to change from remote to local.

7-3-2. Communication address (Addr) setting screen

RS-422A and RS-485 allow connection of a plurality of apparatuses but in fact, communication is carried out between two apparatuses. Therefore, the address of each apparatus is designated by a number between 00 and 99 so as to enable the designated apparatus to respond.

7-3-3. Communication data format (dRFR) selecting screen

Select data format of communication from 7b_E (data bit length : 7 bits, parity : even, stop bit : 1) or 8b_n (data bit length : 8bits, parity : none, stop bit : 1)

7-3-4. Communication rate (bps) selecting screen

A rate of transmission from the controller to the host is selected from among 1200, 2400, 4800 and 9600 bps.

7-3-5. Delay (delay) setting screen

In the case of RS-485, a minimum delay time for transmission from receiving a communication command is set. Delay time is a set value $(0\sim 255) \times 0.1$ msec. Nevertheless, actual delay time includes time for processing the command added to the above delay time.

7-4. Communication protocol

7-4-1. Communication procedure

Communication is carried out for each block and the communication right alternates between the controller and the host from block to block.

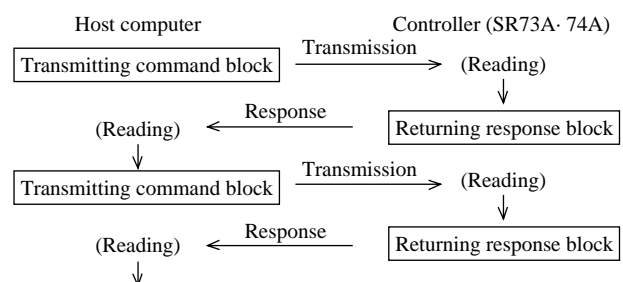

7-4-2. Explanation of block

(1) The data format in one block is shown below:

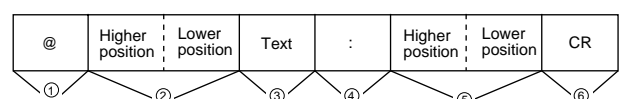

①: Start character ••••• @ (40H) Shows the start of a block.

②: Address (Machine No.)

.....Two digits

Two-digit address data (00~99) set in the controller is divided to the higher position (tens) and the lower position (units) and each is shown by an ASCII code.

③: TextA group of a command and data, in the format of each command.

④: End character.....(3AH) Shows the end of the block.

⑤: BCC checkBCC check data is shown in two digits.

A value obtained by exclusive OR operation of data following @ (data in the higher position of the address) through : is converted to two ASCII characters and shown by two digits in the higher and lower positions.

(Example) BCC operation of DI read command (Address: 01)

@	0	1	D	1	:	BCC	CR
(40H)	(30H)	(31H)	(44H)	(31H)	(3AH)	(34H)(45H)	(0DH)

$$30H \oplus 31H \oplus 44H \oplus 31H \oplus 3AH = 4EH$$

4 E
 \clubsuit BCC=(34H), (45H)

In the above, \oplus = EX-OR (exclusive OR)

⑥: TerminatorCR(0DH) Shows the termination of the data of the block.

- (2) In this protocol, address data is inserted in the block in each transmission or response and so no data link needs to be established or aborted.
- (3) The apparatus which has the address matches the one in the command block, interprets the command, data, etc., and returns a response block by inserting the same address into it. Apparatuses which the addresses do not match the one in the block wait for the next block without activating.
- (4) In the case of receiving block data and the terminator CR is not completed in about 1 second after receiving the start character, it designates a time-out and automatically waits for the next command, that is, the start character @ is being waited for.

7-5. Text

7-5-1. Text format

The text format is classified into read data, write data and response data.

(1) Read Data

Command

 The text format of read data contains only of a command of two characters.

Command	Contents of Read Data
D1	PV value, Execution SV value*1, Control output value, Stop (STBY) status, Manual (MAN) status, AH status, AL/HB status, AT status, SB status.
D2	Set value of higher limit alarm (AH), Set value of lower limit alarm (AL).
D3	Load current value, Set value of heater break alarm (HB).
D4	Set value of set value bias (SB).
D5	Proportional band (P) value, Integral time (I), Derivative time (D) value, Set value of target value function (SF).
D6	Set value of hysteresis (DF).
D7	Set value of manual reset (MR).
D8	Set value of PV bias, Set value of PV filter.
D9	Set value of proportional cycle time.
DA	Set value of lower limit output limiter, Set value of higher limit output limiter.
DB	Set value of soft start time.
DC	Communication mode, Delay time.

*1 The execution SV value is a total of the SV value and the value bias.

(2) Write Data

Command	Write data
---------	------------

 The text format of write data contains a command and write data value.

Command	Contents of Write Data	Attribute	Command	Contents of Write Data	Attribute
E1	SV value *2	Numerical value	F1	PV bias value	Numerical value
E2	Control output value	Numerical value	F2	PV filter value	Numerical value
E3	Stop status	1 byte	F3	Proportional cycle time	Numerical value
E4	Manual status	1 byte	F4	Lower limit output limiter value	Numerical value
E5	AT status	1 byte	F5	Higher limit output limiter value	Numerical value
E6	Higher limit alarm (AH) value	Numerical value	F6	Soft start time value	Numerical value
E7	Lower limit alarm (AL) value	Numerical value	F7	Communication mode	1 byte
E8	Heater break alarm (HB) value	Numerical value			
E9	Set value bias (SB) value	Numerical value			
EA	Proportional band (P) value	Numerical value			
EB	Integral time (I) value	Numerical value			
EC	Derivative time (D) value	Numerical value			
ED	Target value function (SF) value	Numerical value			
EE	Hysteresis (DF) value	Numerical value			
EF	Manual reset (MR) value	Numerical value			

*2 SV value is target set value.

(3) Response Data

Response data has different formats depending on whether read data has been received or write data has been received.

① Response data to read data received

Command	Data 1	,	Data 2	,	Data n
---------	--------	---	--------	---------	--------

Appropriate read data contents of commands shown in the table of the read data text format are sent back.

② Response data to write data received

Command	Write data
---------	------------

The same data as the received write data is sent back.

7-5-2. Data format

The data format is divided to 3 categories; numerical data, 1 byte data and special data.

(1) Numerical Data (-2999~9999)

The length of numerical data in the text is fixed to six characters including a code and a decimal point. A code (+ or -) is attached to the head of the numerical data. In the case where the numerical value including a code is less than six characters, 0 is inserted between the code and the figure or figures to make the value six characters. When a code is excluded, each of the 5 characters is a figure or a decimal point.

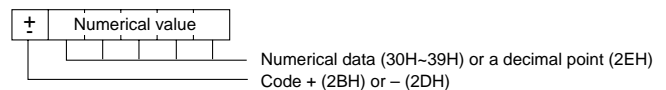

Examples of numerical data

	1	2	3	4	5	6		1	2	3	4	5	6	
1	+	0	0	0	0	1		-1	-	0	0	0	0	1
0.01	+	0	0	.	0	1		-0.01	-	0	0	.	0	1
1234	+	0	1	2	3	4		-123.4	-	1	2	3	.	4
12.34	+	1	2	.	3	4		-12.34	-	1	2	.	3	4
0 or OFF	+	0	0	0	0	0		-0.001	-	0	.	0	0	1

(2) One-Byte Data

One-byte data in the text has a fixed length of one character which is either 0 or 1. Seven items are covered, namely, stop status, manual status, AT status, AH status, AL/HB status and communication mode.

- ① Stop (STBY), Manual (MAN), AT (ON), AH (ON), AL/HB (ON), SB (ON), Communication (when the remote mode is on).

1

- ② Execution (EXEC), Auto (AUTO), AT (OFF), AH (OFF), AL/HB (OFF), SB (OFF), Communication (when the local mode is on).

0

(3) Special Data

Special data is data sent in response to numerical data which are outside of the ordinary range. Their patterns are shown in the following.

- ① Numerical data is +10000~+10999.

10000 U 0 0 0 0 0 0 10999 U 0 0 9 9 9

- ② Numerical data exceeds the indicated range.

more than 11000 D E H 0 0 0 0 less than -3000 D E L 0 0 0 0

- ③ Numerical data is over the scale.

The (+) side H 0 0 0 0 0 0 The (-) side L 0 0 0 0 0 0

- ④ CT temperature exceeded the higher limit value or fell below the lower limit value in the case of thermocouple input.

The higher limit side C J H 0 0 0 0 The lower limit side C J L 0 0 0 0

- ⑤ Wire breaking detected in the case of R.T.D. input

B 0 0 0 0 0 0

- ⑥ CT input value exceeded the higher limit value or fell below the lower limit value.

The higher limit side H B H 0 0 0 0 The lower limit side H B L 0 0 0 0

- ⑦ Control output either turned on or turned off while CT input measurement was ongoing.

- - - - -

- ⑧ Data is undeterminable due to a set value of alarm code, P=OFF, or some other reasons.

- Data in the case where the alarm code is 0 and D2 (AH, AL) or D3 (CT, HB) command has been received.
- Data in the case where the alarm code is 1~4 and D3 (CT, HB) command has been received.
- AL data in the case where the alarm code is 5~8 and D2 (AH, AL) command has been received.
- I, D, SF or MR data in the case where P=OFF and D5 (P, I, D, SF, MR) command has been received.

+ 0 0 0 0 0 0

7-5-3. Communication error

When an error is found in the block after receiving data from the host, an error message is sent back. The format of error messages and the types of errors are described in the following.

① Error Message Format

@ 40H	Address No. Higher Lower position position	E 45H	R 52H	Space 20H	Error No. : : : : :	: 3AH	BCC Higher Lower position position	CR 0DH
-------	--	----------	----------	--------------	------------------------------------	----------	--	-----------

② Error Types

Error No.	Error Type	Description
05	BCC error	Arithmetic value is not in accord with BCC.
06	Command error	Command other than prescribed one was received.
08	Data format error	The format is different from prescribed one.
09	Data error	Value is out of prescribed data range in the case of write command.
11	Write mode error	Write command was received when write command was invalid.
12	Option error	Command of unequipped option was received.

7-5-4. Non-response process

When an error is found in the block upon receiving data transmitted from the host, the next correct data block is waited for without transmission of response data. Therefore, the host has to retransmit the command block in any of the following cases:

- ① The start character was not @ (40H).
- ② The communication No. did not match.
- ③ The end character was not CR (0DH).
- ④ A hardware error such as a framing error, overrun or a parity error occurred.

7-5-5. Restrictions by commands, etc.

(1) Restrictions by Read Command

Upon receiving the D1 read command, the status of unequipped options (AH, AL/HB, SB) become 0 (30H).

(2) Restrictions by Write Command

① **ER09**

In the case of P=OFF and Y and P output, write data of E2 (write command of manual output value) is either of the following two. Otherwise, ER09 is sent back.

0% + 0 0 0 0 0 0 100% + 0 0 1 0 0 0

In the case of P=OFF and V and I output, a lower limit output limiter value or a higher limit output limiter value is to be set.

② **ER11**

If a write command is invalid due to the local mode, a set value of keylock, AT or some other conditions, and that command is received, ER11 should be sent back. The following cases also require ER11 to be sent back.

Condition	Received Write Command
Stop mode (STBY)	E2 (Manual control output value)
	E4 (Manual status)
	E5 (AT status)
Auto mode (AUTO)	E2 (Manual control output value)
Manual mode (MAN)	E5 (AT status)
Alarm code = 0	E6 (Set value of AH)
	E7 (Set value of AL)
	E8 (Set value of HB)
Alarm code = 1~4	E8 (Set value of HB)
Alarm code = 5~8	E7 (Set value of AL)
P≠OFF	EE (DF: Hysteresis)
P=OFF	E5 (AT status)
	EB (I: Integral time)
	EC (D: Derivative time)
	ED (SF: Target value function)
	EF (MR: Manual reset)
I≠OFF	EF (MR: Manual reset)
I=OFF	ED (SF: Target value function)

(3) Restrictions by Read/Write Commands Depending on Equipped Optional Functions

① **ER12**

When a command which becomes invalid because an optional function is not equipped, ER12 should be sent back. (Read commands are included.)

Condition	Received Command
Without alarm option	D2 (AH/AL) read command
	E6 (Set value of AH) write command
	E7 (Set value of AL) write command
Without HB option	D3 (CT/HB) read command
	E8 (Set value of HB) write command
Without SB option	D4 (Set value of SB) read command
	E9 (Set value of SB) write command

(4) Others

When P (proportional band)=OFF is prepared to be set, data is as follows:

OFF

+	0	0	0	.	0
---	---	---	---	---	---

 or

-	0	0	0	.	0
---	---	---	---	---	---

7-6. A list of transmitted/received data

The text portions of data in read commands and write commands are listed below.

Block Data Format

@ 40H	Address No. Higher position, Lower position	Text Data	:	3AH	BCC Higher position, Lower position	CR 0DH
----------	--	-----------	---	-----	--	-----------

7-6-1. Read command

(1) D1

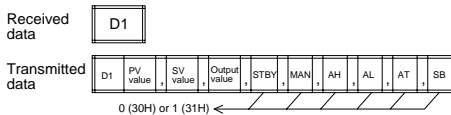

(2) D2

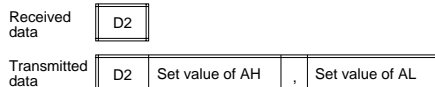

(3) D3

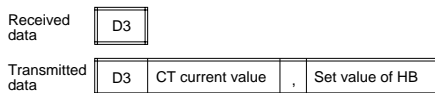

(4) D4



(5) D5

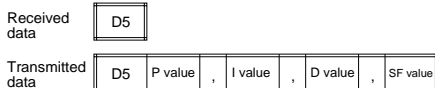

(6) D6

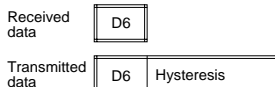

(7) D7

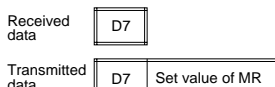

(8) D8

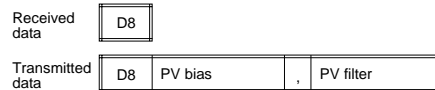

(9) D9

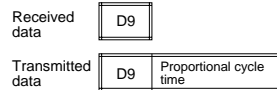

(10) DA

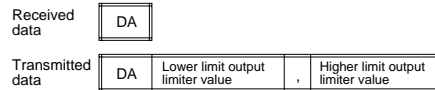

(11) DB

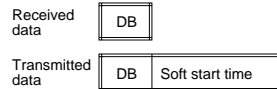

(12) DC

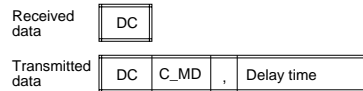

7-6-2. Write command

In write commands, received data and transmitted data are identical.

(1) E1

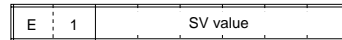

(2) E2

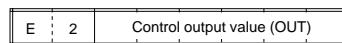

(3) E3



(4) E4



(5) E5



(6) E6

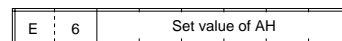

(7) E7

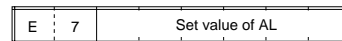

(8) E8

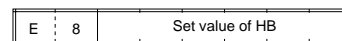

(9) E9

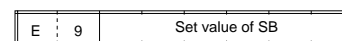

(10) EA

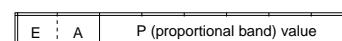

(11) EB

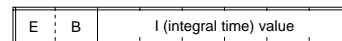

(12) EC

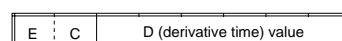

(13) ED

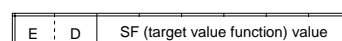

(14) EE

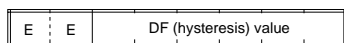

(15) EF

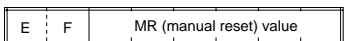

(16) F1

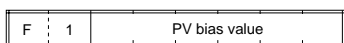

(17) F2

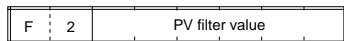

(18) F3

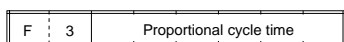

(19) F4

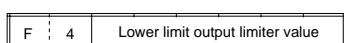

(20) F5

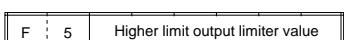

(21) F6

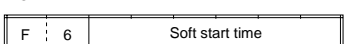

(22) F7

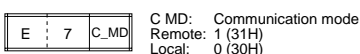

8. Specifications

Display

- Digital display: Measured value (PV)/7-segment green LED 4 digits
Set value (SV) /7-segment orange LED 4 digits
- Parameter display: 7-segment LED for PV and SV
- Action display: Green LEDs for 5 points of output (OUT), auto tuning (AT), operating mode (STBY), remote (COM) and manual output (MAN). Red LEDs for 2 points of alarm (AH, AL/HB).
- Display accuracy: $\pm(0.3\% \text{ FS} + 1 \text{ digit})$ excluding cold junction temperature compensation accuracy in the case of the thermocouple input.
 $\pm 5\% \text{ FS}$ for temperatures below 400°C (750 °F) of thermocouple B.
- Display accuracy range: 23±5 °C (18~28 °C)
- Display resolution: Depends on measuring range (0.001, 0.01, 0.1, 1)
- Measured display range: -10~110% (-210~680 °C for -200~600 °C of R.T.D. input)

Setting

- Setting: By 5 front key switches
- Setting range: Same as measuring range.

Input

- Type of input : Multiple input of Thermocouple, R.T.D., Voltage (mV), or Voltage (V), or Current 4~20mA DC by code selection
- Thermocouple: B, R, S, K, E, J, T, N, {U, L (DIN 43710)} Refer to Measuring range code table.
- External resistance: 100Ω max.
- Input impedance: 500kΩ min.
- Burnout: Standard feature (up scale)
- Cold junction temperature compensation accuracy: $\pm 2^\circ\text{C}$ (°F) (5~45 °C)
 $\pm 5^\circ\text{C}$ to the negative side of

measuring range in case of T and U input, though.

- R.T.D: JIS Pt100 / JPt100 3-wire type
Amperage: Approx. 0.25mA
Lead wire tolerable resistance: 5Ω max. / wire (The 3 lead wires should have same resistance.)
- Voltage : 0~10, 10~50, 0~100mV DC or 0~1, 1~5, 0~10V DC
- Input impedance: 500kΩ min.
- Current: 4~20mA DC
- Receiving impedance: 250Ω
- Input scaling function: Scaling possible for voltage (mV, V) or current (mA) input.
Scaling range: -1999~9999 counts.
Span: 100~5000 counts
Position of decimal point: None, 0.0, 0.00, 0.000
- Sampling cycle: 0.5 sec.
- PV bias range: ± 200 unit
- PV filter: 0~100 sec. (0=without filter)

Control

- Control mode: Auto tuning PID/ ON-OFF control
- Proportional band (P): Off, 0.1~999.9% FS (Off setting: On-Off action)
- Integral time (I): Off, 1~6000 sec. (Off setting: P-PD action)
- Derivative time (D): Off, 1~3600 sec. (Off setting: P-PI action)
- Manual reset (MR): -50.0~50.0% (Valid when P \neq OFF and I=OFF)
- Output limiter: Lower limit limiter 0~99%, Higher limit limiter 1~100% (Priority given to lower limit limiter)
- Soft start of output: Off, 1~100 sec.
- ON/OFF hysteresis: 1~999 units
- Proportional cycle: 1~120 sec. (Factory-set value: 30 sec. for contact output and 3 sec. for SSR drive voltage output.)

- Control output characteristics: RA / DA selectable (set to RA when shipped)
- Set value function (SF) : Off (Off = 0.00) and 0.01~1.00

Control Output

- Contact output: 240V AC 2.5A / resistive load: 1.5A / inductive load
- Current output : 4~20mA DC / load resistance: 600Ω max.
- SSR drive voltage output : 15±3V DC (with load resistance at 1.5kΩ) /load current: 20mA maximum
- Voltage output : 0~10V DC / load current: 2mA maximum

Manual Control

- Output setting range: 0~100% (setting resolution: 1%) but within range set by higher/lower output limiters.
- Auto/manual switching: Balanceless bumpless. Within proportional band range.

Communication (Optional)

- Signal level: EIA standards, conforming with RS-422A and RS-485.
- Communication system: RS-422A 4-wire half duplex multi-drop system. RS-485 2-wire half duplex multi-drop (bus) system.
- Synchronous system: Start-stop synchronous system.
- Data format: Select data format of communication from 7b_E (data bit length: 7bits, parity: even, stop bit: 1) or 8b_n (data bit length: 8bits, parity: none, stop bit: 1)

- Communication address: Machine numbers are set in a range from 0 to 99.
- Communication rate: 1200, 2400, 4800 and 9600 bps.
- Communication delay: To be set in a range from 0 to 255 (Setting possible only in the case of RS-485.)
- Communication distance: RS-422A maximum 1200m (depending on conditions)
RS-485 maximum 500m (depending on conditions)
- Transmission procedure: No procedure.
- Communication code: Conforming with ASCII codes.
- Control signal: Not used.
- Error detection: Vertical parity (even parity) checking.
BCC (block check character) checking.
- Connectable number of apparatuses: Possible to connect 100 units maximum (including the host, depending on conditions)

Alarm Output (Optional)

- Number of alarm points: 2 (AH and AL/HB, both for normal open and common)
- Alarm Type: Selectable from the following 9 combinations. (5 through 8 are selectable only when apparatus has heater break alarm function.)
 0. Not assigned
 1. Higher limit deviation value + lower limit deviation value without inhibit action
 2. Higher limit absolute value + lower limit absolute value without inhibit action
 3. Higher limit deviation value + lower limit deviation value with inhibit action
 4. Higher limit absolute value + lower limit absolute value with inhibit action
 5. Higher limit deviation value without inhibit action + heater break
 6. Higher limit absolute value without inhibit action + heater break
 7. Higher limit deviation value with inhibit action + heater break
 8. Higher limit absolute value with inhibit action + heater break
- Alarm setting range: Higher limit and lower limit absolute value alarms: Within full scale of measuring range
Deviation value: Higher limit: 0~2000 unit
Lower limit: -1999~0 unit
- Alarm action: On-Off action
- Alarm action hysteresis: Fixed to 0.2% of the measuring range
- Alarm output / rating: Contact 1a (common) / 240V AC 1.5A (resistive load)

Heater Break Alarm (option)

This function can be added if the instrument has an alarm option and the control output is the contact type or the SSR drive voltage type.

- Alarm action: Heater amperage detected by externally attached CT. (except 0~5V DC input)
Alarm output On upon detection of heater break while control output is On.

- Current setting range: Off, 0.1~50.0A (Alarm action stops when Off is set.) or, Off, 1~500A (when 0~5 V DC for CT input is selected)
- Setting resolution: 0.1A or 1A
- Amperage display: 0.0~55.0A or 0~550A
- Display accuracy: 5% FS (when sine wave is 50 Hz) or 1% FS (in case of 0~5 V DC input)
- Minimum time for action confirmation: On time: 500 msec.
- Alarm holding: Selectable between Lock (holding) and Real (no holding)
- Sampling cycle: 2 sec.

Set value Bias (option)

- Setting range: -1999~2000 unit
- Setting resolution: Same as display resolution
- Action input: Non-voltage contact (bias in action when SB terminal is closed)

Others

- Data storage: By non-volatile memory (EEPROM)
- Isolation: Input, control output, communication and alarm output circuits are isolated from each other.
Input, set value bias and CT input circuits are not isolated from each other.
- Ambient conditions for use
Temperature/humidity ranges: -10~50 °C and below 90%RH (on the condition that there is no dew condensation)
Height: 2000 m above sea level or lower
Installation category: II
Degree of pollution: 2
- Supply voltage/frequency: 100~260V AC±10% (50 / 60 Hz)
- Power consumption: 12 VA max.
- Insulation resistance: Between input / output terminal and power supply terminal: 500V DC 20 MΩ minimum
Between input / output terminal and protective conductor terminal: 500V DC 20 MΩ minimum
- Dielectric strength: 1 min. at 2300V AC between input / output terminal and power supply terminal
1 min. at 1500V AC between power supply terminal and protective conductor terminal
- Protective structure: Only front panel has simple dust-proof and drip-proof structure
- Material: PPO resin molding (equivalent to UL94V-1)
- External dimensions
SR73A: H96 × W96 × D110 (panel depth: 100)mm
SR74A: H96 × W48 × D110 (panel depth: 100)mm
Push-in panel (one-touch mount)
- Mounting: 1.0~3.5 mm
- Panel thickness: 1.0~3.5 mm
- Panel cutout
SR73A: H92 × W92mm
SR74A: H92 × W45mm
- Weight
SR73A: Approx. 400 g
SR74A: Approx. 300 g

The contents of this manual are subject to change without notice.

Temperature and Humidity Control Specialists
SHIMADEN CO., LTD.

Head Office: 2-30-10 Kitamachi, Nerima-Ku, Tokyo 179-0081 Japan
Phone: +81-3-3931-7891 Fax: +81-3-3931-3089
E-MAIL: exp-dept@shimaden.co.jp URL: http://www.shimaden.co.jp

T0009020
PRINTED IN JAPAN